

SHARP

FP-S90T-W FP-S90T-H

空氣清淨機
使用說明書

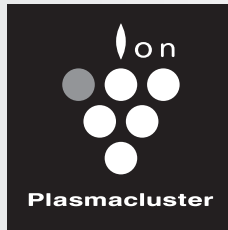

自動除菌離子 25000 *

Plasmacluster 標誌與 Plasmacluster 是
夏普株式會社的註冊商標或商標。



SHARP COCORO AIR

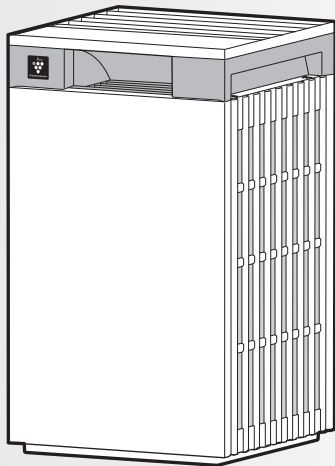

* 本技術標示的數字，為商品置於牆邊，以「強」速
運轉情況下，於自動除菌離子適用地板面積的房間中
央（距離地面大約 1.2 米的高度）所測得之每 1 立方
公分離子數量概略值。

感謝您購買 SHARP 空氣清淨機。
在使用空氣清淨機前，請詳細閱讀本使用說明書。
請將本使用說明書保存於方便隨時查閱的地方。

目錄

特點.....	1	各種功能的變更設定	12
重要安全事項	2	保養與清潔.....	16
各部份名稱	5	維修前的檢查事項	21
準備工作	7	規格.....	23
WI-FI 設定	8	限用物質含有狀況標示	23
操作方法.....	10	本產品所使用的智慧財產權	24

操作空氣清淨機前請先閱讀

空氣清淨機透過吸氣口吸入室內空氣，使其流過產品內部的前置過濾網、活性碳過濾網和集塵 HEPA 過濾網，然後從吹出口排出。集塵 HEPA 過濾網能濾除 99.97% 的 0.3 微米塵埃粒子，也有助於吸收異味。活性碳過濾網可在氣味通過濾網時逐漸加以吸收。

濾網吸收的某些異味會隨著時間而分解，產生其他氣味。視使用條件而定，尤其是在比一般家庭惡劣許多的環境中使用產品的情況下，這些氣味可能會比預期更快變得明顯。如果這些氣味持續存在，請更換濾網。

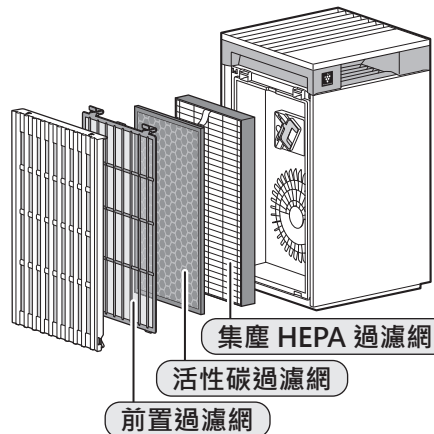

注意

- 空氣清淨機可去除懸浮灰塵和異味。
- 空氣清淨機無法去除有害氣體，例如香菸煙霧中所含的一氧化碳。
- 如果氣味來源仍然存在，空氣清淨機可能無法完全去除氣味。

商標

- 「Wi-Fi®」是 Wi-Fi Alliance® 的註冊商標。
- 「WPA™」、「WPA2™」及 「WPA3™」是 Wi-Fi Alliance® 的商標。
- Bluetooth® 文字商標是 Bluetooth SIG, Inc. 擁有的註冊商標。
- 「Android」是 Google Inc. 的商標。
- 操作說明中提及的其他公司名稱、企業名稱、產品名稱是各公司的商標和註冊商標。

特點

空氣處理技術的獨特組合 三重過濾系統 + 自動除菌離子

吸附灰塵*

前置過濾網能夠吸附灰塵和其他尺寸較大的懸浮粒子。

減少異味

活性碳過濾網能吸收多種常見的家居異味。

減少花粉和黴菌*

集塵 HEPA 過濾網能夠吸附高達 99.97% 的粒徑小至 0.3 微米的粒子。

空氣淨化

自動除菌離子對空氣進行處理的方法，類似於自然界通過釋放平衡濃度的正、負離子而對環境進行淨化的過程。

* 當通過過濾系統吸入空氣時。

適用大小 (根據 JEM1467)

高達 89 平方公尺

應用感應器技術對空氣品質進行不間斷監測，並基於探測到的空氣品質狀況和空氣濕度，自動調整本機的運行。

Wi-Fi 功能



SHARP COCORO AIR

透過「SHARP COCORO AIR」可以智慧遠端控制，即時監控室內空氣品質狀態及耗材狀況；設定「雲端智慧管家」服務，由 SHARP 雲端所分析選擇最適合的設定使其運轉。

- AIoT 智慧遠端控制
- 耗材狀況監控
- 空氣品質狀態監控
等等。

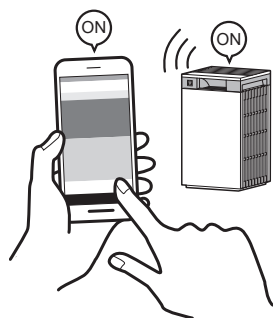

Wi-Fi 連接時

「SHARP COCORO AIR」應用程式中設定「雲端智慧管家」後，配合室內空氣的汙濁程度，由 SHARP 雲端所分析選擇最適合的設定使其運轉。

『SHARP COCORO AIR』智慧運轉

智慧雲端分析提供最佳的運轉模式

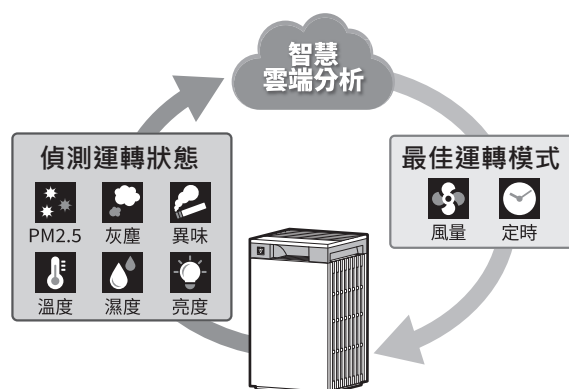

注意

- 顯示面板的亮度會依據室內的狀態自動切換。(將燈光控制設定為「自動」時。參照 13 頁)
- 可變更燈光控制、感應器探測靈敏度調整。(參照 13 頁)

顯示面板

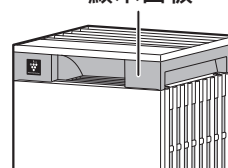

重要安全事項

使用本產品之前，請閱讀並保存本說明書。

使用電器時，應隨時遵守基本安全注意事項以降低火災、觸電和人員受傷的風險，包括：

警告

1. 使用產品前，請閱讀所有說明。
2. 產品僅限用於本手冊中所述的預定居家用途。任何非製造商建議的其他用途都有可能導致火災、觸電或人員受傷。
3. 本電器不適合供生理、感官或心理能力有限或缺乏經驗和知識的人（包括兒童）使用，除非由負責其安全的人監督或指導他們使用電器。應監督兒童以免他們玩弄本電器。
4. 如果電源線或插頭損壞或產品故障或損壞，切勿操作產品。
5. 如果電源線或插頭損壞，必須由製造商、服務代理商、SHARP 授權服務中心或具備類似資格的人員更換，以避免危害。如有任何問題、需要調整或維修，請聯絡當地服務中心。
6. 請勿自行修理或拆解產品。
7. 針對電源線或插頭，請遵照以下說明，否則可能會導致短路、過熱、觸電或火災。
 - a. 僅限使用 AC 110 伏特插座。
 - b. 如果電源線或插頭損壞或與牆壁插座的連接鬆動或損壞，切勿使用產品。
 - c. 在拔下電源插頭之前，請務必關閉產品。
 - d. 在下述情況下，請務必拔下電源插頭。
 - 移動產品前。
 - 更換過濾網時。
 - 僅打開側蓋板時。
 - 維護產品前。
 - 不使用產品時。
 - e. 拔下產品插頭時請務必拉電源插頭，而不是電源線。
 - f. 當從牆壁插座上插入或拔下插頭時，請勿用濕手觸摸電源插頭。
 - g. 定期清除電源插頭上的灰塵。
 - h. 請務必遵守下列事項，以免損壞電源線。
 - 請勿將電線置於地毯下。請勿用腳踏墊、滑槽或類似覆蓋物覆蓋電線。
 - 請勿將重物放在電源線上或擠壓電源

線。

- 請勿將電源線置於家具或其他電器下方。
 - 請將電源線置於遠離走道區域且不會被絆倒的位置。
8. 請勿在燃氣設備、壁爐、燭火、焚香或點燃的香菸火花附近使用本產品。在同一房間內使用產品與燃氣設備時，請定期讓室內通風，否則可能導致一氧化碳中毒。
 9. 請勿在有易燃氣體的室內操作產品，例如油性殘留物或化學煙霧。
 10. 請勿讓產品接觸雨水，或在浴室、洗衣區或其他潮濕位置附近使用。
 11. 請勿將手指或異物插入吹出口或吸氣口。
 12. 請勿直視吹出口。
 13. 請勿在吹出口上方放置物品、花盆或水杯，以避免物品或水滴進入本機導致損壞。

注意

- 無線電或電視干擾 -

如果產品對無線電或電視收訊造成干擾，請嘗試透過下列一或多項措施修正干擾：

1. 調整接收天線的方向或位置。
2. 增加產品與無線電 / 電視接收器之間的距離。
3. 將產品和接收器分別連接至不同電路上的插座。
4. 向經銷商或專業無線電 / 電視技術人員尋求協助。

安裝注意事項

1. 請將產品放在平穩且通風充足的表面上。放在厚地毯上時，產品可能會稍微震動。
2. 如果產品有感應器，請避開使感應器暴露於直接微風或氣流的位置。產品可能無法正常運作。
3. 請避免在家具、織物或其他物品可能接觸並限制吸氣口及 / 或吹出口的位置使用。
4. 請避開陽光直射處。可能導致產品形狀

或顏色改變。

5. 請避免使產品暴露於凝結或劇烈溫度變化的位置。請在 0 °C – 35 °C 之間的適當條件下使用。
6. 請避免在會產生油煙的位置使用 (例如廚房等)。主機表面可能破裂，如果產品有感應器，則感應器可能會因此故障。
7. 吹出口正後方的牆壁和用來放置產品的地板或地毯可能會隨著時間而變髒。在同一位置長時間使用產品時，請定期清潔牆壁、地板或地毯。
8. 請勿將產品放在爐具或加熱器等高溫物體附近或上方，或可能接觸蒸氣的位置。

濾網注意事項

1. 依照本手冊中的說明進行濾網安裝和維護。
(第 7, 18 頁)
2. 從塑膠袋中取出濾網，然後將濾網放入主機。
3. 請勿在未裝好濾網的情況下操作產品。
4. 請勿清洗並重複使用集塵 HEPA 過濾網和活性炭過濾網。
清洗無法改善濾網性能，還有可能導致觸電或運作故障。
5. 請勿在有噴霧殺蟲劑的室內操作產品。
可能導致殺蟲劑的氣味殘留在產品中並從吹出口散發。

操作注意事項

1. 請勿擋住吸氣口或吹出口。
2. 請務必在直立狀態下操作產品。
3. 搬運產品時，請握住產品兩側的把手。
4. 在容易受損的地板、不平整的表面或地毯上移動產品時，請務必抬起產品。
5. 請勿在產品附近使用含有氟樹脂或矽氧樹脂的產品 (化妝品、護髮產品等)。
氟樹脂或矽氧樹脂可能會卡在產品內部，使產品無法產生自動除菌離子。

維護注意事項

1. 依照本手冊中的說明進行維護。(第 16 - 20 頁)
2. 僅限使用軟布清潔外部。
3. 請勿使用本手冊中未提及的清潔劑 (第 17 頁)。請勿使用揮發性流體或清潔

劑。

強腐蝕性清潔劑、石油精、油漆稀釋劑、拋光粉或潤滑脂可能會使主機表面損壞或破裂。此外，如果產品有感應器，感應器可能因此故障。

4. 維護時請勿用力擦洗前置過濾網。
5. 更換濾網或任何配件時，請使用本手冊中指定的零件。

安全 / Wi-Fi 功能注意事項

警告

遠端控制空氣清淨機時

如果從外部遠端操作，可能無法檢查空氣清淨機目前狀態或周圍區域以及附近是否有人，因此，使用前請充分確認安全。

1. 確保電源插頭已完全插入電源插座，且插頭上或插座孔內無灰塵。（可能因接觸不良或接觸失效而導致發熱、燃燒、起火等）
2. 請務必事先檢查產品的周圍環境，因為來自產品的氣流可能導致非預期現象（例如不穩定的物品掉落），並導致火災、受傷、住宅財物污損。

使用注意事項

1. 必須同意「服務條款」才能使用應用程式。
2. 確保應用程式為最新版本。
3. 本手冊中的畫面和圖片僅供參考，與實際產品有一些差異。
4. 在連線品質不佳的情況下，應用程式可能無法控制空氣清淨機。空氣清淨機在目前運作可能無法準確反映在應用程式上。
5. 建議鎖定智慧型裝置螢幕以避免錯誤操作。
6. 下載和使用應用程式將產生通訊費用。

Wi-Fi 注意事項

關於電波的使用注意事項

1. 不保證可在下列環境下使用應用程式：
 - a. 使用與本產品相同頻率 (2.4GHz) 的藍牙無線通訊裝置附近。
 - b. 發出磁場的產品附近。（例如微波爐）
 - c. 有靜電的位置附近。
 - d. 產生無線電干擾的位置附近。
 - e. 其他無線通訊裝置附近。
2. 無法為所有路由器或環境條件保證 Wi-Fi 連線和效能。
3. 在下列位置，Wi-Fi 連線可能會不穩定：
 - a. 以混凝土、鋼筋或金屬製成的建築物內部。
 - b. 障礙物附近。
 - c. 使用相同頻率的無線通訊裝置附近。

個人資訊注意事項（與資安相關）

1. 使用 Wi-Fi 裝置有可能被攔截，無論密碼設定為何。
2. 請務必使用受管理的網路。
3. 出售、處置或從第三方接手 / 交給第三方時，請將裝置初始化。請參閱第 14 頁瞭解如何初始化。

※ 根據 NCC 低功率射頻器材技術規範 3.8.2 規定：

- 取得審驗證明之低功率射頻器材，非經核准，公司、商號或使用者均不得擅自變更頻率、加大功率或變更原設計之特性及功能。
- 低功率射頻器材之使用不得影響飛航安全及干擾合法通信；經發現有干擾現象時，應立即停用，並改善至無干擾時方得繼續使用。前述合法通信，指依電信管理法規定作業之無線電通信。
- 低功率射頻器材須忍受合法通信或工業、科學及醫療用電波輻射性電機設備之干擾。

各部份名稱

主機

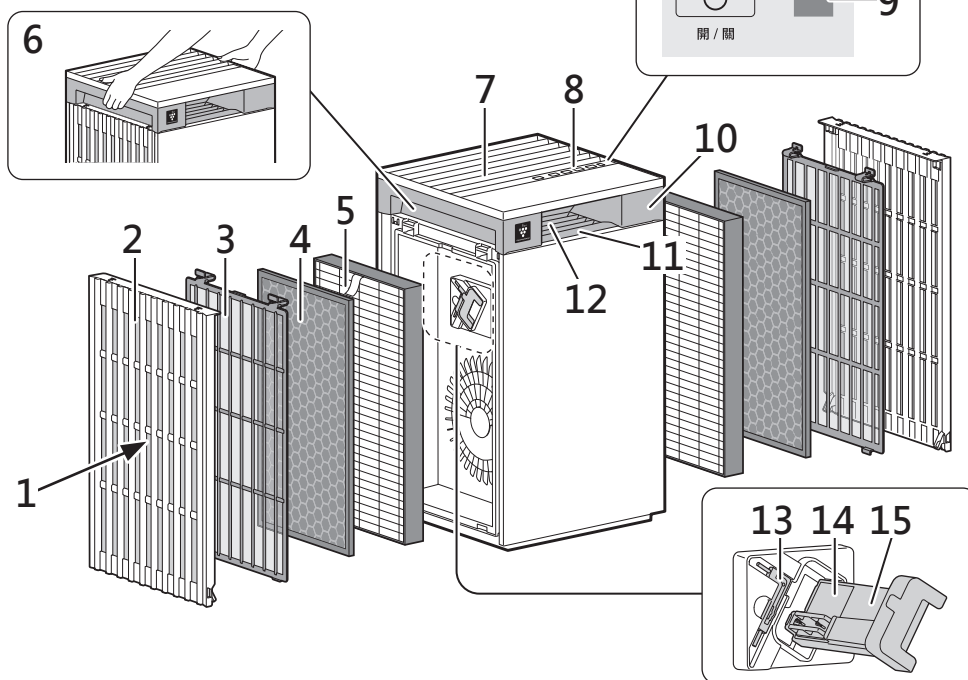

背面

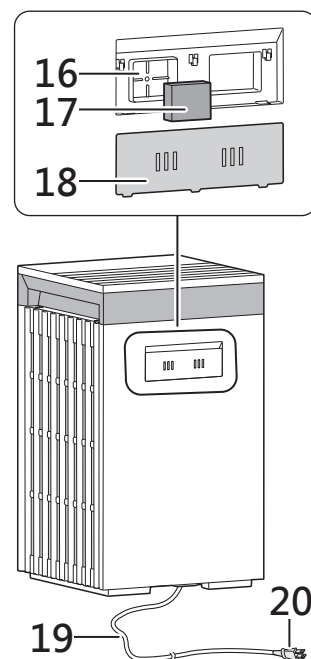

1	吸氣口 (左右)
2	側蓋板 (左右)
3	前置過濾網 (左右)
4	活性炭過濾網 (左右)
5	集塵 HEPA 過濾網 (左右)
6	把手 (左右)
7	吹出口
8	操作面板
9	亮度感應器
10	顯示面板
11	空氣品質指示燈 透過顏色變化以 5 個等級指示室內的空氣品質。 <div style="display: flex; align-items: center; justify-content: center;"> <div style="text-align: center; margin-right: 10px;"> 清淨 ↑ ↓ 污濁 </div> <div style="text-align: center;"> 藍色 黃色 (閃爍) 紅色 (快速閃爍) </div> </div>
12	吹出口 (正面)
13	產生器 * 清掃毛刷 (僅左側)
14	產生器 (自動除菌離子產生器) (僅左側)
15	產生器支架 (僅左側)
16	感應器 (內置) 高感度灰塵 / 高感度異味 / 溫度 / 濕度

17	感應器過濾網
18	感應器蓋
19	電源線
20	電源插頭

* 產生器是指自動除菌離子產生器。(以下相同)

亮度感應器

燈光控制 (顯示面板亮度) 設為「自動」時, 將根據室內亮度自動切換顯示面板和空氣品質指示燈的亮度。(第 13 頁)

注意 亮度感應器的偵測範圍

請勿將產品安裝在以下位置。亮度感應器可能無法正常感應。

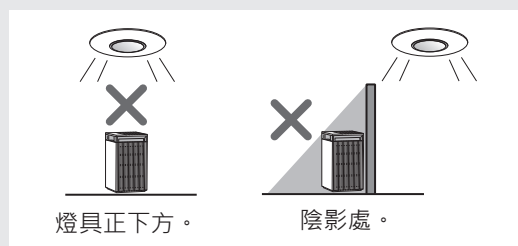

操作面板

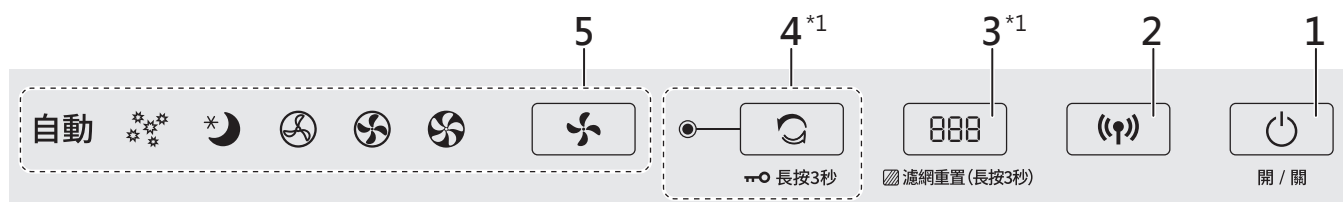

顯示面板

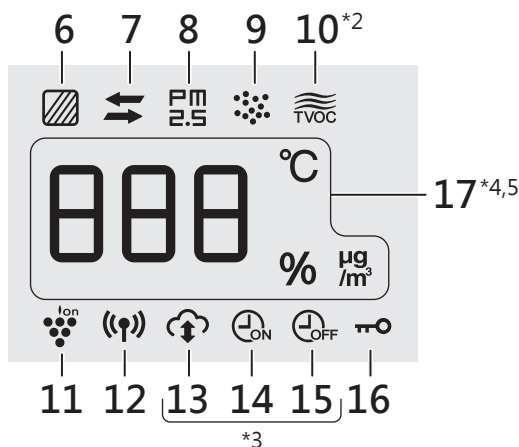

1	電源（開／關）按鈕
2	Wi-Fi 按鈕
3	顯示切換按鈕 過濾網重置按鈕（按住 3 秒）*1
4	淋浴式空氣清淨按鈕、指示燈 兒童安全鎖按鈕（按住 3 秒）*1
5	風量按鈕、指示燈
6	過濾網清潔指示燈（橘色）
7	產生器更換指示燈（紅色）
8	PM2.5 偵測指示燈 表示高感度灰塵感應器偵測到微塵。
9	灰塵偵測指示燈 表示高感度灰塵感應器偵測到一般灰塵。
10	TVOC 偵測指示燈 表示高感度異味感應器偵測到異味和 TVOC。*2 清淨 熄滅 ↕ 白色 污濁 白色（閃爍）
11	自動除菌離子模式指示燈（藍色）
12	Wi-Fi 指示燈 在空氣清淨機連線至路由器時亮起。
13	智慧雲端服務指示燈 *3 在指定應用程式中的「雲端服務」設為開啟時亮起。

14	定時開機指示燈 *3
15	定時關機指示燈 *3
16	兒童安全鎖指示燈
17	顯示面板 *4 <ul style="list-style-type: none"> • 溫度 顯示溫度 0°C 至 50°C。 -1°C 以下 Lo °C ↔ 25 °C ↔ Hi °C 51°C 以上 • 濕度 顯示濕度 25 % 至 75 %。 24% 以下 Lo % ↔ 55 % ↔ Hi % 76% 以上 • PM2.5 濃度 *5 顯示 PM2.5 10 µg/m³（每立方公尺空氣微克）至 499 µg/m³。 9 µg/m³ 以下 Lo ㎍ ↔ 34 ㎍ ↔ Hi ㎍ 500 µg/m³ 以上

*1: 按住 3 秒以上。

*2: 高感度異味感應器無法偵測所有 TVOC。

*3: 13、14、15 號指示燈僅在使用應用程式時亮起。

*4: 顯示的數字是近似值。

*5: 微粒物質，直徑 2.5 微米以下的顆粒。

準備工作

- 為了維持濾網的品質，已將濾網安裝在產品中並裝在塑膠袋中。
- 在安裝或更換濾網之前，請務必停止操作並拔下電源插頭。



濾網安裝

1. 拆下側蓋板。

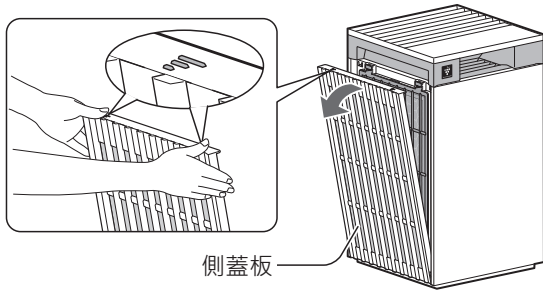

2. 拆下前置過濾網。

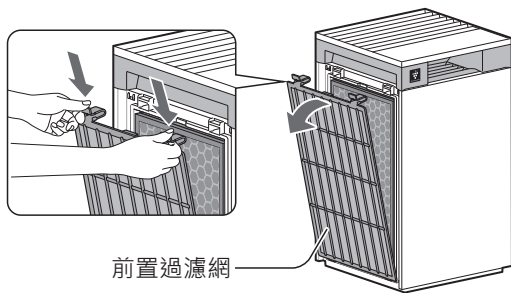

- ① 從塑膠袋中取出濾網。
- ② 取下主機產生器支架上的膠帶。

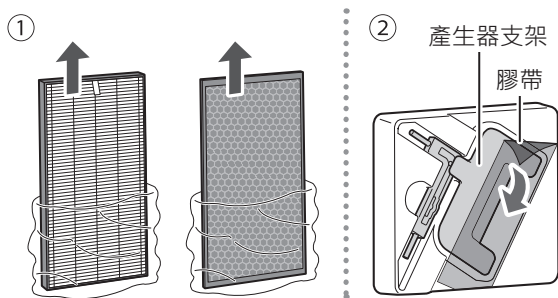

4. 如圖所示，依正確順序安裝濾網。

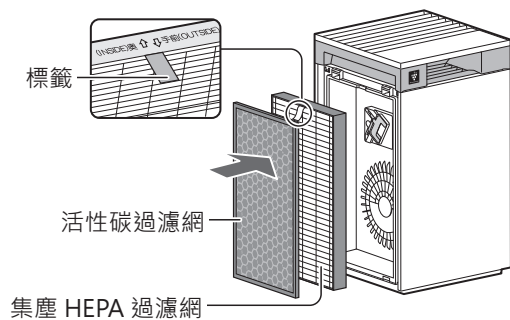

5. 安裝前置過濾網。

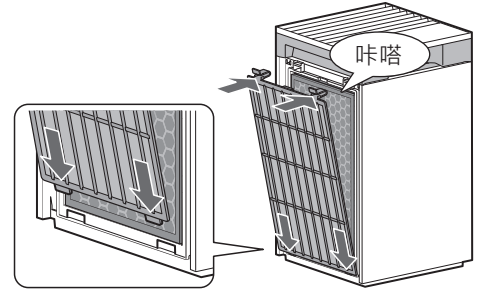

6. 安裝側蓋板。

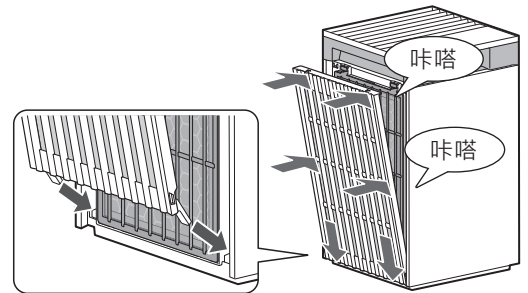

7. 也將過濾網安裝在另一側。

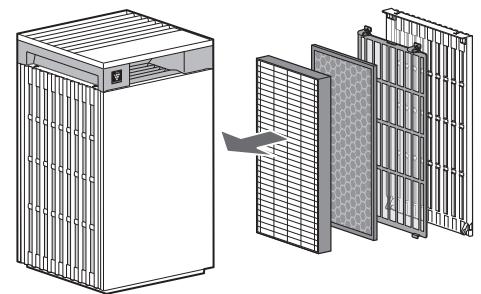

注意

- 建議記下更換過濾網的日期以供日後參考。
- 請勿在沒有濾網的情況下操作產品。

WI-FI 設定

本手冊中的畫面和插圖僅供參考，其與真實產品存在一定差異，請以實際的畫面和插圖為主。

- 將空氣清淨機與智慧型裝置連線，即可更方便地使用空氣清淨機。

使用條件 (截至 2023 年 5 月)

寬頻網路連接

- 以下連接方法將無法使用。
 - 撥號連接
 - 需要身分驗證的連接
- 以下連接方法將無法保證是否可供使用。
 - 使用流動路由器連接
 - 透過網路共用連接

智慧型裝置 (例如智慧手機)

- 最低軟體要求：
Android 8 或以後版本 / iOS 12 或以後版本

Wi-Fi 存取點 (路由器)

本產品支援的 Wi-Fi 規格

- 頻率：
2.4GHz 頻段 / 5GHz 頻段
(IEEE802.11a/b/g/n)
- 頻道：
<2.4GHz 頻段 >
1-11
<5GHz 頻段 >
W52 (36、40、44、48)
W53 (52、56、60、64)
W56 (100、104、108、112、116、120、124、128、132、136、140)
W58 (149、153、157、161、165)
- 安全類型：
WPA 個人版 / WPA2 個人版 / WPA3 個人版
- 建議加密標準：
AES
- Bluetooth® 5.0
(僅支援 Bluetooth Low Energy)

注意

- 請停用以下路由器設定。
 - 隱藏 SSID 的設定
 - MAC 地址過濾設定
 - 禁止在連接至路由器的裝置之間進行 Wi-Fi 通訊的客戶端隔離設定。

初始設定方法

注意

- 使用前請先開啟路由器，並檢查連接方法和安全設定等各種設定。
- 將智慧型裝置與空氣清淨機配對時，請確保兩者連線至同一個路由器。
- 設備的網路名稱將顯示為 “AP-SHARP-XX” (其中 XX 是 MAC 位址的最後兩位數字)。

① 下載和註冊

1. 在智慧型裝置中安裝指定應用程式。



- 可從 Apple Store 或 Google Play 下載。

https://cboard.cloudlabs.sharp.co.jp/smartapp_taiwan/download/air/

2. 將智慧型裝置連上路由器，開始安裝程式。根據應用程式畫面進行操作。

- i. 確認 “使用條款”。
- ii. 輸入 “SHARP 會員帳號”。(SHARP ID)
 - 如果沒有 “SHARP 會員帳號”，請取得新的 “SHARP 會員帳號”。
- iii. 請輸入您的智慧型裝置名稱。

② 空氣清淨機和路由器的連接

1. 點擊 “主畫面” 畫面的 “≡”，選擇 “設備註冊” ⇨ “現在開始連接設備和路由器”。



2. 根據應用程式畫面進行操作。

- 當您看到 Wi-Fi 指示燈亮起，就表示設定完成了。

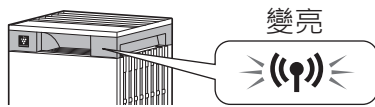

點擊“註冊”。

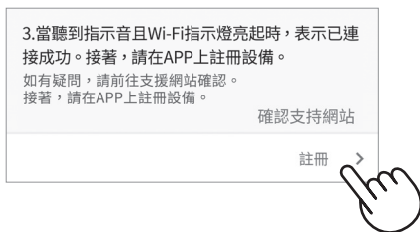

③ 空氣清淨機與智慧型裝置之間的連接

1. 點擊“註冊”查看您要註冊的空氣清淨機。

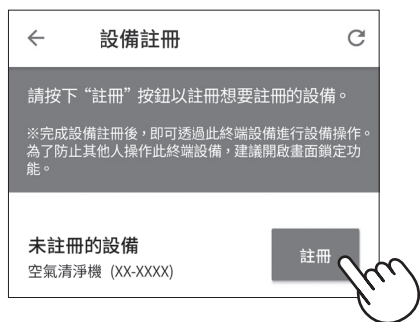

- 若您未看到以上的畫面，請到“主畫面”按下“≡”，選擇“設備註冊” ⇨ “設備已連接至路由器”。



2. 根據應用程式畫面進行操作。

- 當您看到 Wi-Fi 指示燈亮起，就表示設定完成了。



初始設定已完成。

完成初始設定後如何開啟 / 關閉 Wi-Fi

若要關閉 Wi-Fi：



按住 3 秒。



注意

- 關閉 Wi-Fi 將導致無法使用指定應用程式以控制空氣清淨機。

若要再次開啟 Wi-Fi： (如何將 Wi-Fi 連線還原成原始網路。)



按住 3 秒。

按 Wi-Fi 按鈕後，Wi-Fi 指示燈將閃爍。在大約 3 分鐘內，會聽到四次短嗶聲。嗶聲響起一段時間後，Wi-Fi 指示燈亮起，Wi-Fi 連線將還原成原始網路。現在可以再次使用指定應用程式以控制空氣清淨機。

注意

- 也可以從「AI: Wi-Fi 介面卡開啟 / 關閉」開啟 / 關閉 Wi-Fi。
(第 12、14 頁)
在此情況下，將自動還原與路由器的 Wi-Fi 連線。
- 再次開啟 Wi-Fi 後，重新連線至無線路由器可能需要幾分鐘才能完成。

操作方法

運轉開始 / 停止

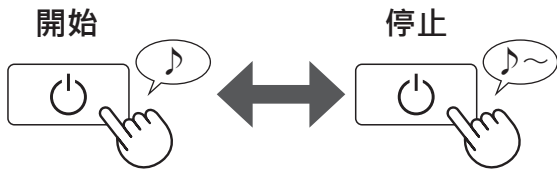

注意

- 當清淨機開始運作時，會以先前的運作模式開始運作。

風量切換

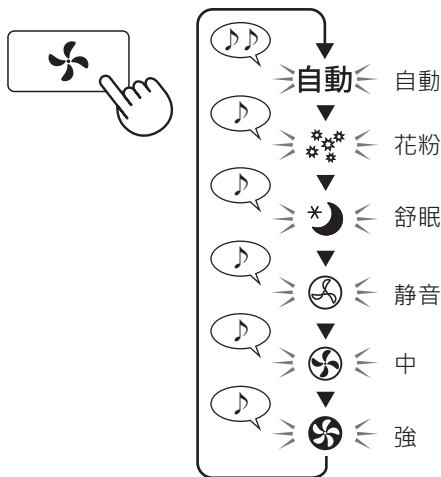

自動：

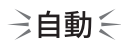

根據空氣中的雜質量和室內亮度自動切換風扇轉速。

花粉：



自動提高高感度灰塵感應器靈敏度，高感度灰塵感應器會快速偵測灰塵、花粉等雜質並強力淨化空氣。

舒眠：



清淨機將安靜運作，風扇轉速將根據空氣中的雜質量和室內亮度而自動切換。
當燈光控制設為「自動」時，顯示面板和空氣品質指示燈將根據室內亮度自動調暗或熄滅。

淋浴式空氣清淨模式

產品以強勁氣流釋放自動除菌離子並收集灰塵持續 10 分鐘，同時減少靜電。之後，會自動提升高感度灰塵感應器靈敏度、快速偵測雜質，並強力淨化空氣持續 50 分鐘。

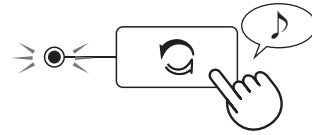

注意

- 當運作 60 分鐘後完成時，產品將回到先前的運作模式。在運作期間可變更為其他模式。
- 無法「關閉」自動除菌離子。

兒童安全鎖

將鎖定操作面板。

(產品開啟或關閉)



鎖定



解除



- 當安全鎖設定為鎖定时，顯示面板上的安全鎖指示燈會亮起。
- 當安全鎖設定解除時，顯示面板上的安全鎖指示燈會熄滅。

注意

- 在兒童安全鎖模式下可以關閉 Wi-Fi。

顯示切換

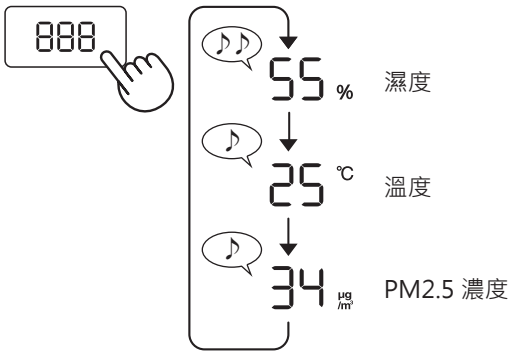

每週排程器： 僅限在應用程式上操作

定時開機 (或定時關機)



您可以為空氣清淨機設定每週排程器，以便在特定日期和時間啟動特定模式 (或停止運作)。有設定排程時，定時指示燈將亮起。

各種功能的變更設定

• 您可以參考第 13 - 16 頁變更產品和 Wi-Fi 功能。

1. 關閉產品。(電源關閉狀態)

2.

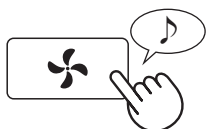

按住 3 秒。

F

Wi-Fi 設定時

從「F」變成「A」。



F

產品
設定

↔

A

Wi-Fi
設定

設定



產品設定

F 1

Wi-Fi 設定

A 1

3. 參考第 13 - 16 頁選擇「功能編號 (F1-F6 或 A1-A9)」。

前進



或

後退

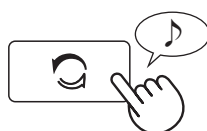

產品設定



Wi-Fi 設定



設定



4.

Wi-Fi 設定時

如需各項功能的詳細資訊，請參閱第 14 - 16 頁。

產品設定時

參考第 13 頁選擇「設定編號 (01 - 03)」。

前進



或

後退



設定



5. 完成設定。

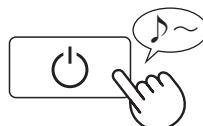

產品功能 (F1-F6)

功能	設定											
<p>F1 <u>燈光控制</u></p> <p>您可以選擇顯示面板和空氣品質指示燈的亮度。</p>	<p>01 熄滅 當設為「熄滅」時，「調暗」燈會在開始運作後亮起 8 秒，然後熄滅。 但某些需要通知的指示燈將保持調暗。</p> <p>02 調暗</p> <p>03 自動 (預設) 燈光根據室內亮度自動切換。</p> <table border="1"> <thead> <tr> <th rowspan="2">室內亮度</th> <th colspan="2">顯示面板和空氣品質指示燈</th> </tr> <tr> <th>所有模式 (舒眠除外)</th> <th>舒眠模式</th> </tr> </thead> <tbody> <tr> <td>明亮</td> <td>亮起</td> <td>調暗</td> </tr> <tr> <td>調暗</td> <td>調暗</td> <td>熄滅</td> </tr> </tbody> </table>	室內亮度	顯示面板和空氣品質指示燈		所有模式 (舒眠除外)	舒眠模式	明亮	亮起	調暗	調暗	調暗	熄滅
室內亮度	顯示面板和空氣品質指示燈											
	所有模式 (舒眠除外)	舒眠模式										
明亮	亮起	調暗										
調暗	調暗	熄滅										
<p>F2 <u>自動除菌離子開啟 / 關閉</u></p>	<p>01 關閉</p> <p>02 開啟 (預設)</p>											
<p>F3 <u>運行自動復位</u></p> <p>如果拔下電源插頭或停電，產品將在復電後以先前的設定繼續運作。</p>	<p>01 取消</p> <p>02 開啟 (預設)</p>											
<p><u>調整感應器靈敏度 (F4 - F6)</u></p>												
<p>F4 亮度感應器</p>	<p>01 低</p>											
<p>F5 高感度灰塵感應器標</p>	<p>02 標準 (預設)</p>											
<p>F6 高感度異味感應器</p>	<p>03 高</p>											

Wi-Fi 功能 (A1-A9)

功能	設定
<p>A1 <u>Wi-Fi 介面卡</u> <u>開啟 / 關閉</u></p>	<ol style="list-style-type: none"> 依照第 12 頁上的步驟 1 - 3 選擇「A1」。 按「顯示切換按鈕」選擇設定「01」或「02」。 <div data-bbox="536 405 1396 546" style="border: 1px solid black; padding: 5px; margin: 10px 0;"> </div> <ol style="list-style-type: none"> 完成 <div data-bbox="804 584 1453 775" style="background-color: #f0f0f0; padding: 5px; margin: 10px 0;"> <p>注意</p> <ul style="list-style-type: none"> 當變更設定編號(「01」或「02」)時，顯示面板上的方形會旋轉，直到設定完成。當設定完成後，會顯示「A2」。 </div>
<p>A2 <u>與路由器的 Wi-Fi 連線</u> (有 WPS 按鈕)</p>	<ol style="list-style-type: none"> 依照第 12 頁上的步驟 1 - 3 選擇「A2」。 顯示「bP」後，按路由器的 WPS 按鈕。 <div data-bbox="531 936 1396 1189" style="border: 1px solid black; padding: 5px; margin: 10px 0;"> </div> <p>如果顯示「bE」，表示發生連線錯誤。請確認路由器正常運作並再試一次。</p> <ol style="list-style-type: none"> 完成
<p>A4 <u>Wi-Fi 功能初始化</u></p>	<ol style="list-style-type: none"> 依照第 12 頁上的步驟 1 - 3 選擇「A4」。 顯示「AC」後，按「風量按鈕」。 <p>如果顯示「dE」，表示發生連線錯誤。請再試一次。</p> <div data-bbox="536 1659 1315 1809" style="border: 1px solid black; padding: 5px; margin: 10px 0;"> </div> <ol style="list-style-type: none"> 完成 <div data-bbox="804 1845 1453 1977" style="background-color: #f0f0f0; padding: 5px; margin: 10px 0;"> <p>注意</p> <ul style="list-style-type: none"> 將已連線至 Wi-Fi 的空氣清淨機初始化時，請從應用程式中刪除該設備。 </div>

功能	設定
A9 藍牙開啟 / 關閉	<ol style="list-style-type: none"> 依照第 12 頁的步驟 1 - 3 選擇「A9」。 按「顯示切換按鈕」選擇設定「01」或「02」。 完成 

保養與清潔

- 為了維持本空氣清淨機的最佳性能，請定期清潔產品，包括濾網。
- 進行任何維護或更換配件之前，請務必停止操作並拔下電源插頭。

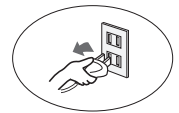

保養

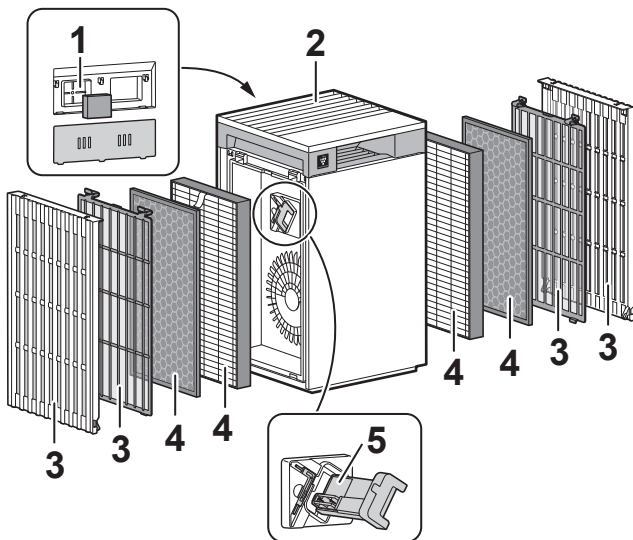

位置	頁碼
1 感應器	17
2 主機	17
3 側蓋板 / 前置過濾網	17
4 集塵 HEPA 過濾網 / 活性炭過濾網	18
5 自動除菌離子產生器	19

過濾網清潔指示燈

當累計運作時間超過約 720 小時，過濾網清潔指示燈將亮起。

- 不會計算拔下電源插頭時的時間。
- 30 天 × 24 小時 = 720 小時

這是執行主機、前置過濾網和感應器維護的提醒。

在維護後，將電源插頭連接至牆壁插座並按電源開 / 關按鈕，然後按住過濾網重置按鈕 3 秒以重置過濾網清潔指示燈。

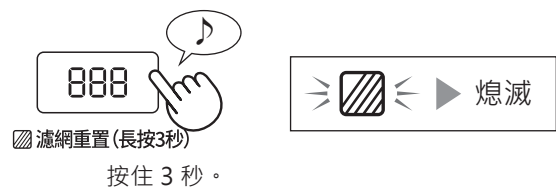

主機

用乾的軟布擦拭。

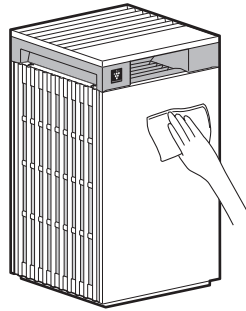

側蓋板 / 前置過濾網

用吸塵器等清潔工具小心清除灰塵。

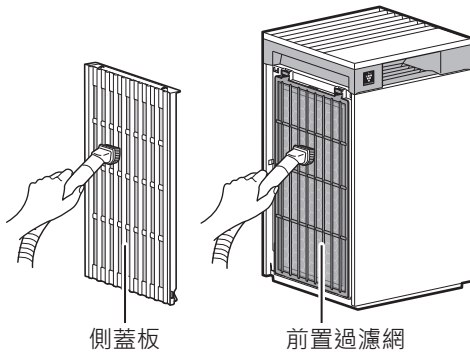

注意

- 擦洗前置過濾網時請勿太過用力。

注意

如何清除頑垢

1. 將少量的中性廚房清潔劑加到水中並浸泡約 10 分鐘。
2. 用清水沖掉中性廚房清潔劑。
3. 讓濾網在通風良好的區域徹底風乾。

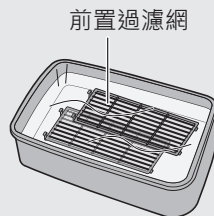

感應器

用吸塵器等清潔工具小心清除灰塵。

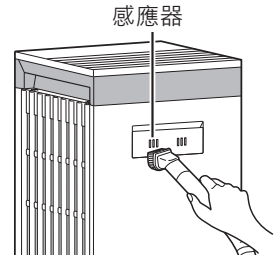

注意

如何清除頑垢

感應器過濾網

1. 拆下感應器蓋。

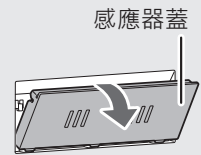

2. 拆下感應器過濾網。
如果感應器過濾網很髒，請用水清洗並徹底風乾。

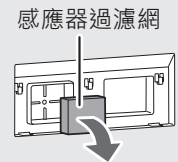

3. 將感應器蓋裝入主機。

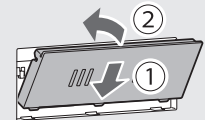

集塵 HEPA 過濾網 / 活性炭過濾網

更換和維護週期

濾網名稱	維護週期	最長使用壽命	替換濾網型號
集塵 HEPA 過濾網	每當積聚灰塵時、當吹出口散發異味時、或每月一次。	10 年 *1,2	FZ-G75H2E
活性炭過濾網			FZ-S70D2E

*1: 根據日本電機工業會 JEM 1467，最長使用壽命以每天 5 支香菸的煙霧相等條件為基礎，與新的濾網相比，集塵 / 除臭能力減半。在更惡劣的條件下，建議更頻繁地更換濾網。

*2: 指定應用程式會根據使用量通知何時應更換各個替換零件。

濾網壽命因室內環境、使用條件和產品位置而異。如果在比一般居家環境更惡劣的情況下 (如 PM2.5) 持續使用本產品，建議更頻繁地更換濾網。

維護

清除濾網上的灰塵。

注意

- 請勿清洗濾網。請勿暴露在陽光下。(否則濾網可能會失去功效。)

集塵 HEPA 過濾網

只維護和清潔有標籤的表面。

請勿清理另一面。

濾網很脆弱，請小心別太過用力。

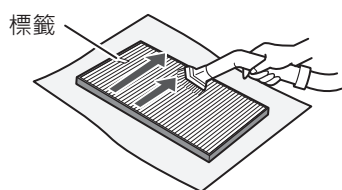

活性炭過濾網

可維護和清潔兩個表面。

濾網很脆弱，請小心別太過用力。

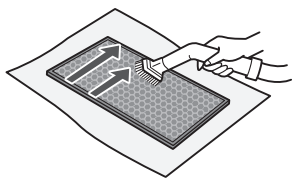

濾網吸收的某些氣味會隨著時間而分解，產生其他氣味。視使用條件而定，尤其是在比一般居家環境更惡劣的情況下持續使用本產品，這些氣味可能會比預期更快變得明顯。

在此情況下或者如果維護後無法清除灰塵，請更換濾網。

更換

請參閱第 7 頁瞭解更換時如何安裝濾網。

- 請洽詢客戶服務中心以購買替換濾網。
- 僅限使用本產品專用的濾網。

建議記下更換過濾網的日期以供日後參考。

FZ-G75H2E
(2 件)

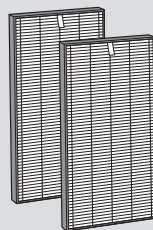

FZ-S70D2E
(2 件)

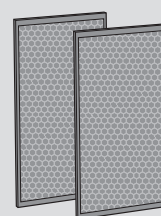

處置濾網

請依據所在地的法規處置換下的濾網。

集塵 HEPA 過濾網材質：
聚丙烯、聚乙烯

活性炭過濾網材質：
聚丙烯、聚酯、活性炭

注意

- 請勿清洗並重複使用換下的濾網。

自動除菌離子產生器 (電極部分)

更換和維護週期

零件名稱	維護週期	最長使用壽命	替換型號
自動除菌離子產生器 *1	每 6 個月一次，必要時更頻繁	19,000 小時 *2,3	IZ-C90ME

*1: 在下文中，「自動除菌離子產生器」簡稱為「產生器」。

*2: 產生器更換指示燈將通知更換時間。

*3: 指定應用程式會根據使用量通知何時應更換各個替換零件。

維護

1. 從主機左側拆下側蓋板和過濾網。

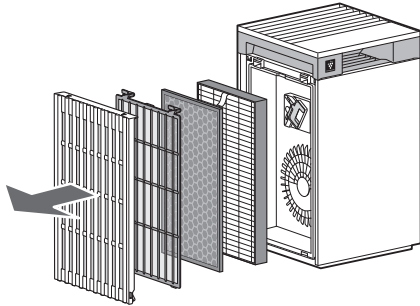

2. ① 抽出產生器支架。
② 拆下產生器清掃毛刷。

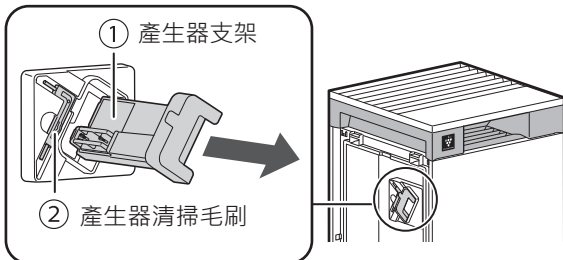

3. 清除電極部分的灰塵。

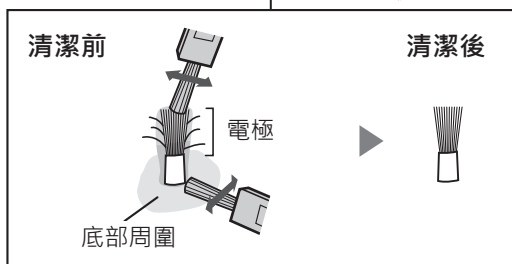
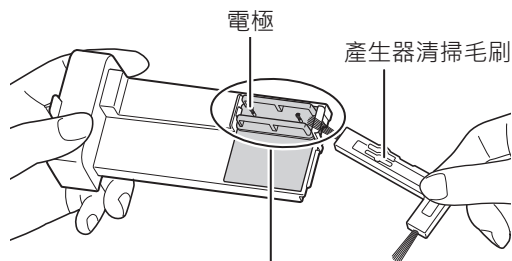

4. ① 裝上產生器清掃毛刷。
② 插入產生器支架。

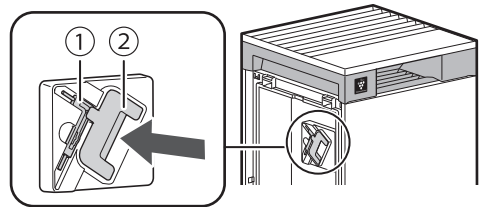

5. 將側蓋板和過濾網裝入主機左側。

注意

- 請勿使用產生器清掃毛刷以外的任何物品清潔，否則可能導致產生器故障。但如果電極的底部被汙染，請用稍微沾濕的棉花棒清潔。
- 彎曲的電極可能在清潔過程中被切斷並掉落，但不會改變性能。
- 請勿直接觸摸電極，否則可能導致疼痛/發癢。
- 請勿改造電極部分，否則可能造成損壞。
- 請勿觸摸連接端子，否則可能造成損壞。

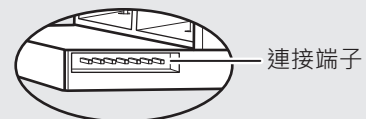

更換

產生器更換指示燈

當總運作時間超過 17,500 小時，產生器更換指示燈將閃爍以表示產生器需要更換。（第 6 頁）

運作時間	說明
17,500 小時  緩慢閃爍	更換產生器。
19,000 小時  快速閃爍	產生器不會釋放自動除菌離子。

* 更換時間與所選的運作模式無關。

如何更換產生器

- 請洽詢客戶服務中心購買替換產生器。
- 僅限使用專為本產品而設計的產生器。

IZ-C90ME
(1 件)

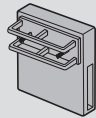

1. 拉開產生器支架的卡勾 (①)，然後拆下產生器 (②)。

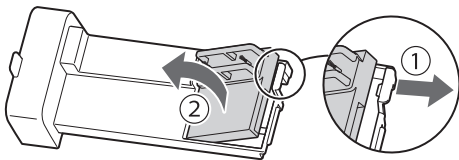

2. 安裝新產生器。

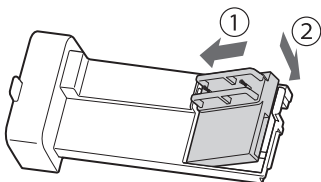

- 將產生器換新後，計時器將重置並回到 19,000 小時。

處置產生器

請依照所在地的法規處置舊產生器。

材質：
聚對苯二甲酸丁二酯，電子零件。

維修前的檢查事項

- 叫修前，請檢閱下列故障排除清單，因為問題可能不是產品故障。

關於產品

異味和煙霧持續存在。

- 檢查濾網。如果看起來非常髒，請加以清潔或更換。

產品排出的空氣有異味。

- 檢查濾網是否非常髒。
- 清潔或更換濾網。

空氣中有香菸煙霧時，產品未運作。

- 確保產品安裝在感應器可偵測香菸煙霧的位置。
- 檢查高感度灰塵感應器開口是否堵塞。如果堵塞，請清潔感應器過濾網。

新產品及 / 或濾網散發氣味。

- 移除塑膠袋後，可能會產生輕微的氣味。此氣味對濾網性能或人體無害。

產品發出咔嗒聲或滴答聲。

- 當產品產生離子時，可能會發出咔嗒聲或滴答聲。

即使空氣不乾淨，空氣品質指示燈也亮藍燈。

- 在插入電源插頭時，空氣可能很髒。拔下電源插頭，等待一分鐘，然後再次插入電源插頭。

即使空氣乾淨，空氣品質指示燈也亮紅燈。

- 高感度灰塵感應器開口變髒或堵塞會干擾感應器運作。小心清潔感應器過濾網。
- 後方的感應器零件是否被牆壁擋住？
⇒ 如果覺得潔淨度指示燈的反應很慢，請將產品置於離牆壁約 3cm 處。

空氣品質指示燈頻繁改變顏色。

- 空氣品質指示燈會在高感度灰塵感應器和高感度異味感應器偵測到雜質時自動改變顏色。如果在意變化，可變更感應器靈敏度。(第12、13頁)

過濾網清潔指示燈亮起。

- 每當進行維護或更換過濾網後，請將電源線連接至插座，然後按住過濾網重置按鈕超過 3 秒。(第 16 頁)

顯示面板熄滅。

- 燈光控制設為「熄滅」時，燈光一律熄滅。如果不想讓燈光熄滅，請將燈光控制設為「自動」或「調暗」設定。(第 12、13 頁)
- 在舒眠模式下，燈光控制設定為「自動」時，燈光將會根據室內亮度自動調暗或熄滅。

顯示內容與氣象報告或室內的其他濕度計和溫度計不符。

- 室外和室內以及居家環境(附近的車流量、家中的樓層數等)可能導致讀數與這些資料不同。
- 同一房間內的位準有差異。

顯示 E9。

- 確保已正確插入自動除菌離子產生器。抽出自動除菌離子產生器並再次插到底，然後再次進行操作。

顯示以下其中之一。

[1] [4] [6] [8] ---

- 拔下電源插頭，等待一分鐘，然後再次插入電源插頭。

關於 Wi-Fi 功能

無法執行空氣清淨機與路由器的 Wi-Fi 連線。

- 檢查所用路由器的規格。
- 調整路由器和天線方向、將路由器和天線移近一些等等。之後，重新切換以開啟路由器並再次執行初始設定。

無法建立空氣清淨機與智慧型裝置之間的連線。

- 空氣清淨機與智慧型裝置是否連線至同一個路由器？
 - ⇒ 將空氣清淨機與智慧型裝置連線至同一個路由器。
 - 如果仍然無法連線，請嘗試將智慧型裝置連線至路由器的 2.4GHz 頻段或 5GHz 頻段。
- 使用的智慧型裝置總數是否超過一部空氣清淨機的註冊數量上限？
 - ⇒ 在一部空氣清淨機上可註冊的智慧型裝置數量上限為 10。
- 使用一部智慧型裝置註冊的產品（空調、空氣清淨機等）總數是否超過指定數量上限？
 - ⇒ 使用一部智慧型裝置註冊的產品數量上限為 30。

無法從智慧型裝置遠端操作。

- 空氣清淨機的 Wi-Fi 指示燈是否亮起？
 - ⇒ 如果 Wi-Fi 指示燈熄滅，請執行「A1：Wi-Fi 介面卡開啟/關閉」以開啟產品 Wi-Fi。（第 14 頁）
- 是否已完成空氣清淨機與智慧型裝置之間的連線？
 - ⇒ 建立空氣清淨機與智慧型裝置之間的連線。（第 9 頁）
- 空氣清淨機的 Wi-Fi 指示燈是否閃爍？
 - ⇒ 如果 Wi-Fi 指示燈閃爍，請在網際網路上檢查通訊狀態。
- 將空氣清淨機的電源插頭插入插座之後，可能需要一些時間 Wi-Fi 指示燈才會亮起。Wi-Fi 指示燈未亮時，無法透過智慧型裝置操作產品。

變更路由器時

- 必須將空氣清淨機重新連線至路由器。
 1. 按住「Wi-Fi」按鈕 3 秒以停止 Wi-Fi 功能。
 2. 執行「初始設定：② 空氣清淨機和路由器的連接」。（第 8 頁）

變更智慧型裝置時

- 執行下述步驟。
 1. 從指定應用程式中的「裝置管理」刪除舊智慧型裝置的註冊。
 2. 使用新的智慧型裝置執行「初始設定：
 - ① 下載和註冊，以及
 - ③ 空氣清淨機與智慧型裝置之間的連接。」（第 8、9 頁）

準備處置或移交空氣清淨機時

- 執行下述步驟以防止個人資訊外洩。
 1. 從指定應用程式中刪除空氣清淨機的註冊。
 2. 執行「A4：Wi-Fi 功能初始化」。（第 14 頁）

如果從第三方接手空氣清淨機

- 為了防止第三方未經授權存取，請執行「A4：Wi-Fi 功能初始化」。（第 14 頁）

Wi-Fi 指示燈緩慢閃爍

- 下列狀態的其中之一。
 - A. 正在設定空氣清淨機與路由器的 Wi-Fi 連線。
 - B. 正在設定空氣清淨機與智慧型裝置的連線。
 - C. 正在更新空氣清淨機的 Wi-Fi 功能軟體。

Wi-Fi 指示燈快速閃爍

- 網路錯誤。請從「A7：顯示 Wi-Fi 網路狀態」確認 Wi-Fi 網路狀態。（第 15 頁）

Wi-Fi 指示燈熄滅

- 空氣清淨機無法連線至路由器。檢查下列事項。
 - A. 是否正確連接電源插頭？
 - B. 是否已停止 Wi-Fi 功能？從「A7：顯示 Wi-Fi 網路狀態」確認 Wi-Fi 網路狀態。（第 15 頁）

在 Wi-Fi 設定模式下，無法選擇「A2」至「A6」的其中之一。（第 14 - 15 頁）

- 如果 Wi-Fi 介面卡關閉，可能無法選擇「A2」至「A6」的其中之一。

需要進一步協助嗎？

請前往下方網站

<https://tw.sharp/aiot/support>



規格

型號	FP-S90T-W / FP-S90T-H		
電源	110 V ~ 60 Hz		
運轉模式	強	中	靜音
風量 (m ³ / 小時)	648	378	144
額定功率 (W)	56.4	18.0	5.3
噪音 (dBA) *1	53	41	24
待機功率 (W) (無線區域網卡開啟時)	1.52		
潔淨空氣提供率 (cmm)	10.16		
能源效率 (cmm / W)	0.180		
空氣清淨推薦適用的房間大小 (m ²) *2	~ 89		
高濃度自動除菌離子濃度適用面積 (m ²) *3	~ 35		
感應器	高感度灰塵 / 高感度異味 / 燈光 / 溫度 / 濕度		
過濾網種類	HEPA*4 / 除臭		
電源線長度 (m)	2.0		
外形尺寸 (mm)	333 (寬) × 330 (深) × 578 (高)		
重量 (kg)	約 10.5		

- *1 • 根據日本電機工業會的 JEM1467 標準測量噪音位準。
- *2 • 建議的房間大小適合以最大風扇轉速運作產品。
 • 建議的房間大小是一間在 30 分鐘內可去除一定數量灰塵顆粒的面積 (根據 JEM1467)。
 • 建議的房間大小 (根據 CNS16098) : 52.7 m²
 空氣清淨機適用之室內面積 (m²) = 潔淨空氣提供率值 × 5.19
- *3 • 產品靠近牆壁，以「強」模式設定運作，離地高度約為 1.2 公尺時，可在房間中心測量大約每立方公分 25000 個離子的房間大小。
- *4 • 濾網可去除超過 99.97% 的 0.3 微米顆粒 (根據 JEM1467)。

待機功率

當產品的電源插頭插入插座時，會消耗待機功率以使電路運作。
 為了節約能源，請在產品不使用時拔下電源線。

限用物質含有狀況標示

設備名稱：空氣清淨機，型號（型式）：FP-S90T-W / FP-S90T-H						
單元	限用物質及其化學符號					
	鉛 (Pb)	汞 (Hg)	鎘 (Cd)	六價鉻 (Cr ⁺⁶)	多溴聯苯 (PBB)	多溴二苯醚 (PBDE)
電路板	-	○	○	○	○	○
電動機	-	○	○	○	○	○
電源線	-	○	○	○	○	○
外殼	○	○	○	○	○	○

備考 1. “○” 係指該項限用物質之百分比含量未超出百分比含量基準值。
 備考 2. “-” 係指該項限用物質為排除項目。

本產品所使用的智慧財產權

■ Software structure

Software installed in this product is structured with multiple independent software components, each of them has our or third-party's copyright.

■ Software of our development and free software

Among the software components of this product, for software we developed or created and incidental documents has our copyright. And they are protected by copyright law, international regulation and other related laws. Also this product uses software components distributed as free software with third-party's copyright.

■ Obligation of license indication

Some software components installed in this product are required to indicate the license by those copyright holders.

License indications of such software components are as below:

●Expat

Copyright (c) 1998, 1999, 2000 Thai Open Source Software Center Ltd and Clark Cooper
Copyright (c) 2001, 2002, 2003, 2004, 2005, 2006 Expat maintainers.

Permission is hereby granted, free of charge, to any person obtaining a copy of this software and associated documentation files (the "Software"), to deal in the Software without restriction, including without limitation the rights to use, copy, modify, merge, publish, distribute, sublicense, and/or sell copies of the Software, and to permit persons to whom the Software is furnished to do so, subject to the following conditions:

The above copyright notice and this permission notice shall be included in all copies or substantial portions of the Software.

THE SOFTWARE IS PROVIDED "AS IS", WITHOUT WARRANTY OF ANY KIND, EXPRESS OR IMPLIED, INCLUDING BUT NOT LIMITED TO THE WARRANTIES OF MERCHANTABILITY, FITNESS FOR A PARTICULAR PURPOSE AND NONINFRINGEMENT. IN NO EVENT SHALL THE AUTHORS OR COPYRIGHT HOLDERS BE LIABLE FOR ANY CLAIM, DAMAGES OR OTHER LIABILITY, WHETHER IN AN ACTION OF CONTRACT, TORT OR OTHERWISE, ARISING FROM, OUT OF OR IN CONNECTION WITH THE SOFTWARE OR THE USE OR OTHER DEALINGS IN THE SOFTWARE.

●Wslay

The MIT License
Copyright (c) 2011, 2012 Tatsuhiro Tsujikawa

Permission is hereby granted, free of charge, to any person obtaining a copy of this software and associated documentation files (the "Software"), to deal in the Software without restriction, including without limitation the rights to use, copy, modify, merge, publish, distribute, sublicense, and/or sell copies of the Software, and to permit persons to whom the Software is furnished to do so, subject to the following conditions:

The above copyright notice and this permission notice shall be included in all copies or substantial portions of the Software.

THE SOFTWARE IS PROVIDED "AS IS", WITHOUT WARRANTY OF ANY KIND, EXPRESS OR IMPLIED, INCLUDING BUT NOT LIMITED TO THE WARRANTIES OF MERCHANTABILITY, FITNESS FOR A PARTICULAR PURPOSE AND NONINFRINGEMENT. IN NO EVENT SHALL THE AUTHORS OR COPYRIGHT HOLDERS BE LIABLE FOR ANY CLAIM, DAMAGES OR OTHER LIABILITY, WHETHER IN AN ACTION OF CONTRACT, TORT OR OTHERWISE, ARISING FROM, OUT OF OR IN CONNECTION WITH THE SOFTWARE OR THE USE OR OTHER DEALINGS IN THE SOFTWARE.

●libFLAC

Copyright (C) 2000-2009 Josh Coalsion
Copyright (C) 2011-2014 Xiph.Org Foundation

Redistribution and use in source and binary forms, with or without modification, are permitted provided that the following conditions are met:

- Redistributions of source code must retain the above copyright notice, this list of conditions and the following disclaimer.

- Redistributions in binary form must reproduce the above copyright notice, this list of conditions and the following disclaimer in the documentation and/or other materials provided with the distribution.

- Neither the name of the Xiph.org Foundation nor the names of its contributors may be used to endorse or promote products derived from this software without specific prior written permission.

THIS SOFTWARE IS PROVIDED BY THE COPYRIGHT HOLDERS AND CONTRIBUTORS "AS IS" AND ANY EXPRESS OR IMPLIED WARRANTIES, INCLUDING, BUT NOT LIMITED TO, THE IMPLIED WARRANTIES OF MERCHANTABILITY AND FITNESS FOR A PARTICULAR PURPOSE ARE DISCLAIMED. IN NO EVENT SHALL THE FOUNDATION OR CONTRIBUTORS BE LIABLE FOR ANY DIRECT, INDIRECT, INCIDENTAL, SPECIAL, EXEMPLARY, OR CONSEQUENTIAL DAMAGES (INCLUDING, BUT NOT LIMITED TO, PROCUREMENT OF SUBSTITUTE GOODS OR SERVICES; LOSS OF USE, DATA, OR PROFITS; OR BUSINESS INTERRUPTION) HOWEVER CAUSED AND ON ANY THEORY OF LIABILITY, WHETHER IN CONTRACT, STRICT LIABILITY, OR TORT (INCLUDING NEGLIGENCE OR OTHERWISE) ARISING IN ANY WAY OUT OF THE USE OF THIS SOFTWARE, EVEN IF ADVISED OF THE POSSIBILITY OF SUCH DAMAGE.

●lwIP

Copyright (c) 2001, 2002 Swedish Institute of Computer Science. All rights reserved.

Redistribution and use in source and binary forms, with or without modification, are permitted provided that the following conditions are met:

1. Redistributions of source code must retain the above copyright notice, this list of conditions and the following disclaimer.
2. Redistributions in binary form must reproduce the above copyright notice, this list of conditions and the following disclaimer in the documentation and/or other materials provided with the distribution.
3. The name of the author may not be used to endorse or promote products derived from this software without specific prior written permission.

THIS SOFTWARE IS PROVIDED BY THE AUTHOR "AS IS" AND ANY EXPRESS OR IMPLIED WARRANTIES, INCLUDING, BUT NOT LIMITED TO, THE IMPLIED WARRANTIES OF MERCHANTABILITY AND FITNESS FOR A PARTICULAR PURPOSE ARE DISCLAIMED. IN NO EVENT SHALL THE AUTHOR BE LIABLE FOR ANY DIRECT, INDIRECT, INCIDENTAL, SPECIAL, EXEMPLARY, OR CONSEQUENTIAL DAMAGES (INCLUDING, BUT NOT LIMITED TO, PROCUREMENT OF SUBSTITUTE GOODS OR SERVICES; LOSS OF USE, DATA, OR PROFITS; OR BUSINESS INTERRUPTION) HOWEVER CAUSED AND ON ANY THEORY OF LIABILITY,

WHETHER IN CONTRACT, STRICT LIABILITY, OR TORT (INCLUDING NEGLIGENCE OR OTHERWISE) ARISING IN ANY WAY OUT OF THE USE OF THIS SOFTWARE, EVEN IF ADVISED OF THE POSSIBILITY OF SUCH DAMAGE.

This file is part of the lwIP TCP/IP stack.

Author: Adam Dunkels <adam@sics.se>

●JSMN

Copyright (c) 2010 Serge A. Zaitsev

Permission is hereby granted, free of charge, to any person obtaining a copy of this software and associated documentation files (the "Software"), to deal in the Software without restriction, including without limitation the rights to use, copy, modify, merge, publish, distribute, sublicense, and/or sell copies of the Software, and to permit persons to whom the Software is furnished to do so, subject to the following conditions:

The above copyright notice and this permission notice shall be included in all copies or substantial portions of the Software.

THE SOFTWARE IS PROVIDED "AS IS", WITHOUT WARRANTY OF ANY KIND, EXPRESS OR IMPLIED, INCLUDING BUT NOT LIMITED TO THE WARRANTIES OF MERCHANTABILITY, FITNESS FOR A PARTICULAR PURPOSE AND NONINFRINGEMENT. IN NO EVENT SHALL THE AUTHORS OR COPYRIGHT HOLDERS BE LIABLE FOR ANY CLAIM, DAMAGES OR OTHER LIABILITY, WHETHER IN AN ACTION OF CONTRACT, TORT OR OTHERWISE, ARISING FROM, OUT OF OR IN CONNECTION WITH THE SOFTWARE OR THE USE OR OTHER DEALINGS IN THE SOFTWARE.

●mbedTLS

Copyright (C) 2006-2015, ARM Limited, All Rights Reserved

Licensed under the Apache License, Version 2.0 (the "License");
you may not use this file except in compliance with the License.
You may obtain a copy of the License at

<http://www.apache.org/licenses/LICENSE-2.0>

Unless required by applicable law or agreed to in writing, software distributed under the License is distributed on an "AS IS" BASIS, WITHOUT WARRANTIES OR CONDITIONS OF ANY KIND, either express or implied. See the License for the specific language governing permissions and limitations under the License.

●wpa supplicant

Copyright (c) 2003-2017, Jouni Malinen <j@w1.fi> and contributors All Rights Reserved.

Redistribution and use in source and binary forms, with or without modification, are permitted provided that the following conditions are met:

1. Redistributions of source code must retain the above copyright notice, this list of conditions and the following disclaimer.
2. Redistributions in binary form must reproduce the above copyright notice, this list of conditions and the following disclaimer in the documentation and/or other materials provided with the distribution.
3. Neither the name(s) of the above-listed copyright holder(s) nor the names of its contributors may be used to endorse or promote products derived from this software without specific prior written permission.

THIS SOFTWARE IS PROVIDED BY THE COPYRIGHT HOLDERS AND CONTRIBUTORS "AS IS" AND ANY EXPRESS OR IMPLIED WARRANTIES, INCLUDING, BUT NOT LIMITED TO, THE IMPLIED WARRANTIES OF MERCHANTABILITY AND FITNESS FOR A PARTICULAR PURPOSE ARE DISCLAIMED. IN NO EVENT SHALL THE COPYRIGHT OWNER OR CONTRIBUTORS BE LIABLE FOR ANY DIRECT, INDIRECT, INCIDENTAL, SPECIAL, EXEMPLARY, OR CONSEQUENTIAL DAMAGES (INCLUDING, BUT NOT LIMITED TO, PROCUREMENT OF SUBSTITUTE GOODS OR SERVICES; LOSS OF USE, DATA, OR PROFITS; OR BUSINESS INTERRUPTION) HOWEVER CAUSED AND ON ANY THEORY OF LIABILITY, WHETHER IN CONTRACT, STRICT LIABILITY, OR TORT (INCLUDING NEGLIGENCE OR OTHERWISE) ARISING IN ANY WAY OUT OF THE USE OF THIS SOFTWARE, EVEN IF ADVISED OF THE POSSIBILITY OF SUCH DAMAGE.

●newLib

(1) Red Hat Incorporated

Copyright (c) 1994-2009 Red Hat, Inc. All rights reserved.

This copyrighted material is made available to anyone wishing to use, modify, copy, or redistribute it subject to the terms and conditions of the BSD License. This program is distributed in the hope that it will be useful, but WITHOUT ANY WARRANTY expressed or implied, including the implied warranties of MERCHANTABILITY or FITNESS FOR A PARTICULAR PURPOSE. A copy of this license is available at <http://www.opensource.org/licenses>. Any Red Hat trademarks that are incorporated in the source code or documentation are not subject to the BSD License and may only be used or replicated with the express permission of Red Hat, Inc.

(2) University of California, Berkeley

Copyright (c) 1981-2000 The Regents of the University of California. All rights reserved.

Redistribution and use in source and binary forms, with or without modification, are permitted provided that the following conditions are met:

- * Redistributions of source code must retain the above copyright notice, this list of conditions and the following disclaimer.
- * Redistributions in binary form must reproduce the above copyright notice, this list of conditions and the following disclaimer in the documentation and/or other materials provided with the distribution.
- * Neither the name of the University nor the names of its contributors may be used to endorse or promote products derived from this software without specific prior written permission.

THIS SOFTWARE IS PROVIDED BY THE COPYRIGHT HOLDERS AND CONTRIBUTORS "AS IS" AND ANY EXPRESS OR IMPLIED WARRANTIES, INCLUDING, BUT NOT LIMITED TO, THE IMPLIED WARRANTIES OF MERCHANTABILITY AND FITNESS FOR A PARTICULAR PURPOSE ARE DISCLAIMED. IN NO EVENT SHALL THE COPYRIGHT OWNER OR CONTRIBUTORS BE LIABLE FOR ANY DIRECT, INDIRECT, INCIDENTAL, SPECIAL, EXEMPLARY, OR CONSEQUENTIAL DAMAGES (INCLUDING, BUT NOT LIMITED TO, PROCUREMENT OF SUBSTITUTE GOODS OR SERVICES; LOSS OF USE, DATA, OR PROFITS; OR BUSINESS INTERRUPTION) HOWEVER CAUSED AND ON ANY THEORY OF LIABILITY, WHETHER IN CONTRACT, STRICT LIABILITY, OR TORT (INCLUDING NEGLIGENCE OR OTHERWISE) ARISING IN ANY WAY OUT OF THE USE OF THIS SOFTWARE, EVEN IF ADVISED OF THE POSSIBILITY OF SUCH DAMAGE.

(3) David M. Gay (AT&T 1991, Lucent 1998)

The author of this software is David M. Gay.

Copyright (c) 1991 by AT&T.

Permission to use, copy, modify, and distribute this software for any purpose without fee is hereby granted, provided that this entire notice is included in all copies of any software which is or includes a copy or modification of this software and in all copies of the supporting documentation for such software.

THIS SOFTWARE IS BEING PROVIDED "AS IS", WITHOUT ANY EXPRESS OR IMPLIED WARRANTY. IN PARTICULAR, NEITHER THE AUTHOR NOR AT&T MAKES ANY REPRESENTATION OR WARRANTY OF ANY KIND CONCERNING THE MERCHANTABILITY OF THIS SOFTWARE OR ITS FITNESS FOR ANY PARTICULAR PURPOSE.

The author of this software is David M. Gay.

Copyright (C) 1998-2001 by Lucent Technologies
All Rights Reserved

Permission to use, copy, modify, and distribute this software and its documentation for any purpose and without fee is hereby granted, provided that the above copyright notice appear in all copies and that both that the copyright notice and this permission notice and warranty disclaimer appear in supporting documentation, and that the name of Lucent or any of its entities not be used in advertising or publicity pertaining to distribution of the software without specific, written prior permission.

LUCENT DISCLAIMS ALL WARRANTIES WITH REGARD TO THIS SOFTWARE, INCLUDING ALL IMPLIED WARRANTIES OF MERCHANTABILITY AND FITNESS. IN NO EVENT SHALL LUCENT OR ANY OF ITS ENTITIES BE LIABLE FOR ANY SPECIAL, INDIRECT OR CONSEQUENTIAL DAMAGES OR ANY DAMAGES WHATSOEVER RESULTING FROM LOSS OF USE, DATA OR PROFITS, WHETHER IN AN ACTION OF CONTRACT, NEGLIGENCE OR OTHER TORTIOUS ACTION, ARISING OUT OF OR IN CONNECTION WITH THE USE OR PERFORMANCE OF THIS SOFTWARE.

(4) Advanced Micro Devices

Copyright 1989, 1990 Advanced Micro Devices, Inc.

This software is the property of Advanced Micro Devices, Inc (AMD) which specifically grants the user the right to modify, use and distribute this software provided this notice is not removed or altered. All other rights are reserved by AMD.

AMD MAKES NO WARRANTY OF ANY KIND, EXPRESS OR IMPLIED, WITH REGARD TO THIS SOFTWARE. IN NO EVENT SHALL AMD BE LIABLE FOR INCIDENTAL OR CONSEQUENTIAL DAMAGES IN CONNECTION WITH OR ARISING FROM THE FURNISHING, PERFORMANCE, OR USE OF THIS SOFTWARE.

So that all may benefit from your experience, please report any problems or suggestions about this software to the 29K Technical Support Center at 800-29-29-AMD (800-292-9263) in the USA, or 0800-89-1131 in the UK, or 0031-11-1129 in Japan, toll free. The direct dial number is 512-462-4118.

Advanced Micro Devices, Inc.
29K Support Products
Mail Stop 573
5900 E. Ben White Blvd.
Austin, TX 78741
800-292-9263

(7) Sun Microsystems

Copyright (C) 1993 by Sun Microsystems, Inc. All rights reserved.

Developed at SunPro, a Sun Microsystems, Inc. business. Permission to use, copy, modify, and distribute this software is freely granted, provided that this notice is preserved.

(8) Hewlett Packard

(c) Copyright 1986 HEWLETT-PACKARD COMPANY

To anyone who acknowledges that this file is provided "AS IS" without any express or implied warranty; permission to use, copy, modify, and distribute this file for any purpose is hereby granted without fee, provided that the above copyright notice and this notice appears in all copies, and that the name of Hewlett-Packard Company not be used in advertising or publicity pertaining to distribution of the software without specific, written prior permission. Hewlett-Packard Company makes no representations about the suitability of this software for any purpose.

(9) Hans-Peter Nilsson

Copyright (C) 2001 Hans-Peter Nilsson

Permission to use, copy, modify, and distribute this software is freely granted, provided that the above copyright notice, this notice and the following disclaimer are preserved with no changes.

THIS SOFTWARE IS PROVIDED "AS IS" AND WITHOUT ANY EXPRESS OR IMPLIED WARRANTIES, INCLUDING, WITHOUT LIMITATION, THE IMPLIED WARRANTIES OF MERCHANTABILITY AND FITNESS FOR A PARTICULAR PURPOSE.

(11) Christopher G. Demetrios

Copyright (c) 2001 Christopher G. Demetrios
All rights reserved.

Redistribution and use in source and binary forms, with or without modification, are permitted provided that the following conditions are met:
1. Redistributions of source code must retain the above copyright notice, this list of conditions and the following disclaimer.
2. Redistributions in binary form must reproduce the above copyright notice, this list of conditions and the following disclaimer in the documentation and/or other materials provided with the distribution.
3. The name of the author may not be used to endorse or promote products derived from this software without specific prior written permission.

THIS SOFTWARE IS PROVIDED BY THE AUTHOR "AS IS" AND ANY EXPRESS OR IMPLIED WARRANTIES, INCLUDING, BUT NOT LIMITED TO, THE IMPLIED WARRANTIES OF MERCHANTABILITY AND FITNESS FOR A PARTICULAR PURPOSE ARE DISCLAIMED. IN NO EVENT SHALL THE AUTHOR BE LIABLE FOR ANY DIRECT, INDIRECT, INCIDENTAL, SPECIAL, EXEMPLARY, OR CONSEQUENTIAL DAMAGES (INCLUDING, BUT NOT LIMITED TO, PROCUREMENT OF SUBSTITUTE GOODS OR SERVICES; LOSS OF USE, DATA, OR PROFITS; OR BUSINESS INTERRUPTION) HOWEVER CAUSED AND ON ANY THEORY OF LIABILITY, WHETHER IN CONTRACT, STRICT LIABILITY, OR TORT (INCLUDING NEGLIGENCE OR OTHERWISE) ARISING IN ANY WAY OUT OF THE USE OF THIS SOFTWARE, EVEN IF ADVISED OF THE POSSIBILITY OF SUCH DAMAGE.

(12) SuperH, Inc.

Copyright 2002 SuperH, Inc. All rights reserved

This software is the property of SuperH, Inc (SuperH) which specifically grants the user the right to modify, use and distribute this software provided this notice is not removed or altered. All other rights are reserved by SuperH.

SUPERH MAKES NO WARRANTY OF ANY KIND, EXPRESS OR IMPLIED, WITH REGARD TO THIS SOFTWARE. IN NO EVENT SHALL SUPERH BE LIABLE FOR INDIRECT, SPECIAL, INCIDENTAL OR CONSEQUENTIAL DAMAGES IN CONNECTION WITH OR ARISING FROM THE FURNISHING, PERFORMANCE, OR USE OF THIS SOFTWARE.

So that all may benefit from your experience, please report any problems or suggestions about this software to the SuperH Support Center via e-mail at softwaresupport@superh.com.

SuperH, Inc.
405 River Oaks Parkway
San Jose
CA 95134
USA

(13) Royal Institute of Technology

Copyright (c) 1999 Kungliga Tekniska Högskolan
(Royal Institute of Technology, Stockholm, Sweden).
All rights reserved.

Redistribution and use in source and binary forms, with or without modification, are permitted provided that the following conditions are met:

1. Redistributions of source code must retain the above copyright notice, this list of conditions and the following disclaimer.
2. Redistributions in binary form must reproduce the above copyright notice, this list of conditions and the following disclaimer in the documentation and/or other materials provided with the distribution.
3. Neither the name of KTH nor the names of its contributors may be used to endorse or promote products derived from this software without specific prior written permission.

THIS SOFTWARE IS PROVIDED BY KTH AND ITS CONTRIBUTORS "AS IS" AND ANY EXPRESS OR IMPLIED WARRANTIES, INCLUDING, BUT NOT LIMITED TO, THE IMPLIED WARRANTIES OF MERCHANTABILITY AND FITNESS FOR A PARTICULAR PURPOSE ARE DISCLAIMED. IN NO EVENT SHALL KTH OR ITS CONTRIBUTORS BE LIABLE FOR ANY DIRECT, INDIRECT, INCIDENTAL, SPECIAL, EXEMPLARY, OR CONSEQUENTIAL DAMAGES (INCLUDING, BUT NOT LIMITED TO, PROCUREMENT OF SUBSTITUTE GOODS OR SERVICES; LOSS OF USE, DATA, OR PROFITS; OR BUSINESS INTERRUPTION) HOWEVER CAUSED AND ON ANY THEORY OF LIABILITY, WHETHER IN CONTRACT, STRICT LIABILITY, OR TORT (INCLUDING NEGLIGENCE OR OTHERWISE) ARISING IN ANY WAY OUT OF THE USE OF THIS SOFTWARE, EVEN IF ADVISED OF THE POSSIBILITY OF SUCH DAMAGE.

(14) Alexey Zelkin

Copyright (c) 2000, 2001 Alexey Zelkin <phantom@FreeBSD.org>
All rights reserved.

Redistribution and use in source and binary forms, with or without modification, are permitted provided that the following conditions are met:

1. Redistributions of source code must retain the above copyright notice, this list of conditions and the following disclaimer.
2. Redistributions in binary form must reproduce the above copyright notice, this list of conditions and the following disclaimer in the documentation and/or other materials provided with the distribution.

THIS SOFTWARE IS PROVIDED BY THE AUTHOR AND CONTRIBUTORS "AS IS" AND ANY EXPRESS OR IMPLIED WARRANTIES, INCLUDING, BUT NOT LIMITED TO, THE IMPLIED WARRANTIES OF MERCHANTABILITY AND FITNESS FOR A PARTICULAR PURPOSE ARE DISCLAIMED. IN NO EVENT SHALL THE AUTHOR OR CONTRIBUTORS BE LIABLE FOR ANY DIRECT, INDIRECT, INCIDENTAL, SPECIAL, EXEMPLARY, OR CONSEQUENTIAL DAMAGES (INCLUDING, BUT NOT LIMITED TO, PROCUREMENT OF SUBSTITUTE GOODS OR SERVICES; LOSS OF USE, DATA, OR PROFITS; OR BUSINESS INTERRUPTION) HOWEVER CAUSED AND ON ANY THEORY OF LIABILITY, WHETHER IN CONTRACT, STRICT LIABILITY, OR TORT (INCLUDING NEGLIGENCE OR OTHERWISE) ARISING IN ANY WAY OUT OF THE USE OF THIS SOFTWARE, EVEN IF ADVISED OF THE POSSIBILITY OF SUCH DAMAGE.

(15) Andrey A. Chernov

Copyright (C) 1997 by Andrey A. Chernov, Moscow, Russia.
All rights reserved.

Redistribution and use in source and binary forms, with or without modification, are permitted provided that the following conditions are met:

1. Redistributions of source code must retain the above copyright notice, this list of conditions and the following disclaimer.
2. Redistributions in binary form must reproduce the above copyright notice, this list of conditions and the following disclaimer in the documentation and/or other materials provided with the distribution.

THIS SOFTWARE IS PROVIDED BY THE AUTHOR "AS IS" AND ANY EXPRESS OR IMPLIED WARRANTIES, INCLUDING, BUT NOT LIMITED TO, THE IMPLIED WARRANTIES OF MERCHANTABILITY AND FITNESS FOR A PARTICULAR PURPOSE ARE DISCLAIMED. IN NO EVENT SHALL THE REGENTS OR CONTRIBUTORS BE LIABLE FOR ANY DIRECT, INDIRECT, INCIDENTAL, SPECIAL, EXEMPLARY, OR CONSEQUENTIAL DAMAGES (INCLUDING, BUT NOT LIMITED TO, PROCUREMENT OF SUBSTITUTE GOODS OR SERVICES; LOSS OF USE, DATA, OR PROFITS; OR BUSINESS INTERRUPTION) HOWEVER CAUSED AND ON ANY THEORY OF LIABILITY, WHETHER IN CONTRACT, STRICT LIABILITY, OR TORT (INCLUDING NEGLIGENCE OR OTHERWISE) ARISING IN ANY WAY OUT OF THE USE OF THIS SOFTWARE, EVEN IF ADVISED OF THE POSSIBILITY OF SUCH DAMAGE.

(16) FreeBSD

Copyright (c) 1997-2002 FreeBSD Project.
All rights reserved.

Redistribution and use in source and binary forms, with or without modification, are permitted provided that the following conditions are met:

1. Redistributions of source code must retain the above copyright notice, this list of conditions and the following disclaimer.
2. Redistributions in binary form must reproduce the above copyright notice, this list of conditions and the following disclaimer in the documentation and/or other materials provided with the distribution.

THIS SOFTWARE IS PROVIDED BY THE AUTHOR AND CONTRIBUTORS "AS IS" AND ANY EXPRESS OR IMPLIED WARRANTIES, INCLUDING, BUT NOT LIMITED TO, THE IMPLIED WARRANTIES OF MERCHANTABILITY AND FITNESS FOR A PARTICULAR PURPOSE ARE DISCLAIMED. IN NO EVENT SHALL THE AUTHOR OR CONTRIBUTORS BE LIABLE FOR ANY DIRECT, INDIRECT, INCIDENTAL, SPECIAL, EXEMPLARY, OR CONSEQUENTIAL DAMAGES (INCLUDING, BUT NOT LIMITED TO, PROCUREMENT OF SUBSTITUTE GOODS OR SERVICES; LOSS OF USE, DATA, OR PROFITS; OR BUSINESS INTERRUPTION) HOWEVER CAUSED AND ON ANY THEORY OF LIABILITY, WHETHER IN CONTRACT, STRICT LIABILITY, OR TORT (INCLUDING NEGLIGENCE OR OTHERWISE) ARISING IN ANY WAY OUT OF THE USE OF THIS SOFTWARE, EVEN IF ADVISED OF THE POSSIBILITY OF SUCH DAMAGE.

(17) S. L. Moshier

Author: S. L. Moshier.

Copyright (c) 1984,2000 S.L. Moshier

Permission to use, copy, modify, and distribute this software for any purpose without fee is hereby granted, provided that this entire notice is included in all copies of any software which is or includes a copy or modification of this software and in all copies of the supporting documentation for such software.

THIS SOFTWARE IS BEING PROVIDED "AS IS", WITHOUT ANY EXPRESS OR IMPLIED WARRANTY. IN PARTICULAR, THE AUTHOR MAKES NO REPRESENTATION OR WARRANTY OF ANY KIND CONCERNING THE MERCHANTABILITY OF THIS SOFTWARE OR ITS FITNESS FOR ANY PARTICULAR PURPOSE.

(18) Citrus Project

Copyright (c)1999 Citrus Project,
All rights reserved.

Redistribution and use in source and binary forms, with or without modification, are permitted provided that the following conditions are met:

1. Redistributions of source code must retain the above copyright notice, this list of conditions and the following disclaimer.
2. Redistributions in binary form must reproduce the above copyright notice, this list of conditions and the following disclaimer in the documentation and/or other materials provided with the distribution.

THIS SOFTWARE IS PROVIDED BY THE AUTHOR AND CONTRIBUTORS "AS IS" AND ANY EXPRESS OR IMPLIED WARRANTIES, INCLUDING, BUT NOT LIMITED TO, THE IMPLIED WARRANTIES OF MERCHANTABILITY AND FITNESS FOR A PARTICULAR PURPOSE ARE DISCLAIMED. IN NO EVENT SHALL THE AUTHOR OR CONTRIBUTORS BE LIABLE FOR ANY DIRECT, INDIRECT, INCIDENTAL, SPECIAL, EXEMPLARY, OR CONSEQUENTIAL DAMAGES (INCLUDING, BUT NOT LIMITED TO, PROCUREMENT OF SUBSTITUTE GOODS OR SERVICES; LOSS OF USE, DATA, OR PROFITS; OR BUSINESS INTERRUPTION) HOWEVER CAUSED AND ON ANY THEORY OF LIABILITY, WHETHER IN CONTRACT, STRICT LIABILITY, OR TORT (INCLUDING NEGLIGENCE OR OTHERWISE) ARISING IN ANY WAY OUT OF THE USE OF THIS SOFTWARE, EVEN IF ADVISED OF THE POSSIBILITY OF SUCH DAMAGE.

(19) Todd C. Miller

Copyright (c) 1998 Todd C. Miller <Todd.Miller@courtesan.com>
All rights reserved.

Redistribution and use in source and binary forms, with or without modification, are permitted provided that the following conditions are met:

1. Redistributions of source code must retain the above copyright notice, this list of conditions and the following disclaimer.
2. Redistributions in binary form must reproduce the above copyright notice, this list of conditions and the following disclaimer in the documentation and/or other materials provided with the distribution.
3. The name of the author may not be used to endorse or promote products derived from this software without specific prior written permission.

THIS SOFTWARE IS PROVIDED "AS IS" AND ANY EXPRESS OR IMPLIED WARRANTIES, INCLUDING, BUT NOT LIMITED TO, THE IMPLIED WARRANTIES OF MERCHANTABILITY AND FITNESS FOR A PARTICULAR PURPOSE ARE DISCLAIMED. IN NO EVENT SHALL THE AUTHOR BE LIABLE FOR ANY DIRECT, INDIRECT, INCIDENTAL, SPECIAL, EXEMPLARY, OR CONSEQUENTIAL DAMAGES (INCLUDING, BUT NOT LIMITED TO, PROCUREMENT OF SUBSTITUTE GOODS OR SERVICES; LOSS OF USE, DATA, OR PROFITS; OR BUSINESS INTERRUPTION) HOWEVER CAUSED AND ON ANY THEORY OF LIABILITY, WHETHER IN CONTRACT, STRICT LIABILITY, OR TORT (INCLUDING NEGLIGENCE OR OTHERWISE) ARISING IN ANY WAY OUT OF THE USE OF THIS SOFTWARE, EVEN IF ADVISED OF THE POSSIBILITY OF SUCH DAMAGE.

(20) DJ Delorie (i386 / arm)
Copyright (C) 1991 DJ Delorie
All rights reserved.

Redistribution, modification, and use in source and binary forms is permitted provided that the above copyright notice and following paragraph are duplicated in all such forms.

This file is distributed WITHOUT ANY WARRANTY; without even the implied warranty of MERCHANTABILITY or FITNESS FOR A PARTICULAR PURPOSE.

(26) Mike Barcroft

Copyright (c) 2001 Mike Barcroft <mike@FreeBSD.org>
All rights reserved.

Redistribution and use in source and binary forms, with or without modification, are permitted provided that the following conditions are met:

1. Redistributions of source code must retain the above copyright notice, this list of conditions and the following disclaimer.
2. Redistributions in binary form must reproduce the above copyright notice, this list of conditions and the following disclaimer in the documentation and/or other materials provided with the distribution.

THIS SOFTWARE IS PROVIDED BY THE AUTHOR AND CONTRIBUTORS "AS IS" AND ANY EXPRESS OR IMPLIED WARRANTIES, INCLUDING, BUT NOT LIMITED TO, THE IMPLIED WARRANTIES OF MERCHANTABILITY AND FITNESS FOR A PARTICULAR PURPOSE ARE DISCLAIMED. IN NO EVENT SHALL THE AUTHOR OR CONTRIBUTORS BE LIABLE FOR ANY DIRECT, INDIRECT, INCIDENTAL, SPECIAL, EXEMPLARY, OR CONSEQUENTIAL DAMAGES (INCLUDING, BUT NOT LIMITED TO, PROCUREMENT OF SUBSTITUTE GOODS OR SERVICES; LOSS OF USE, DATA, OR PROFITS; OR BUSINESS INTERRUPTION) HOWEVER CAUSED AND ON ANY THEORY OF LIABILITY, WHETHER IN CONTRACT, STRICT LIABILITY, OR TORT (INCLUDING NEGLIGENCE OR OTHERWISE) ARISING IN ANY WAY OUT OF THE USE OF THIS SOFTWARE, EVEN IF ADVISED OF THE POSSIBILITY OF SUCH DAMAGE.

(35) - ARM Ltd (arm and thumb variant targets only)

Copyright (c) 2009-2015 ARM Ltd
All rights reserved.

Redistribution and use in source and binary forms, with or without modification, are permitted provided that the following conditions are met:

1. Redistributions of source code must retain the above copyright notice, this list of conditions and the following disclaimer.
2. Redistributions in binary form must reproduce the above copyright notice, this list of conditions and the following disclaimer in the documentation and/or other materials provided with the distribution.
3. The name of the company may not be used to endorse or promote products derived from this software without specific prior written permission.

THIS SOFTWARE IS PROVIDED BY ARM LTD "AS IS" AND ANY EXPRESS OR IMPLIED WARRANTIES, INCLUDING, BUT NOT LIMITED TO, THE IMPLIED WARRANTIES OF MERCHANTABILITY AND FITNESS FOR A PARTICULAR PURPOSE ARE DISCLAIMED. IN NO EVENT SHALL ARM LTD BE LIABLE FOR ANY DIRECT, INDIRECT, INCIDENTAL, SPECIAL, EXEMPLARY, OR CONSEQUENTIAL DAMAGES (INCLUDING, BUT NOT LIMITED TO, PROCUREMENT OF SUBSTITUTE GOODS OR SERVICES; LOSS OF USE, DATA, OR PROFITS; OR BUSINESS INTERRUPTION) HOWEVER CAUSED AND ON ANY THEORY OF LIABILITY, WHETHER IN CONTRACT, STRICT LIABILITY, OR TORT (INCLUDING NEGLIGENCE OR OTHERWISE) ARISING IN ANY WAY OUT OF THE USE OF THIS SOFTWARE, EVEN IF ADVISED OF THE POSSIBILITY OF SUCH DAMAGE.

(41) Ed Schouten - Free BSD

Copyright (c) 2008 Ed Schouten <ed@FreeBSD.org>
All rights reserved.

Redistribution and use in source and binary forms, with or without modification, are permitted provided that the following conditions are met:

1. Redistributions of source code must retain the above copyright notice, this list of conditions and the following disclaimer.
2. Redistributions in binary form must reproduce the above copyright notice, this list of conditions and the following disclaimer in the documentation and/or other materials provided with the distribution.

THIS SOFTWARE IS PROVIDED BY THE AUTHOR AND CONTRIBUTORS "AS IS" AND ANY EXPRESS OR IMPLIED WARRANTIES, INCLUDING, BUT NOT LIMITED TO, THE IMPLIED WARRANTIES OF MERCHANTABILITY AND FITNESS FOR A PARTICULAR PURPOSE ARE DISCLAIMED. IN NO EVENT SHALL THE AUTHOR OR CONTRIBUTORS BE LIABLE FOR ANY DIRECT, INDIRECT, INCIDENTAL, SPECIAL, EXEMPLARY, OR CONSEQUENTIAL DAMAGES (INCLUDING, BUT NOT LIMITED TO, PROCUREMENT OF SUBSTITUTE GOODS OR SERVICES; LOSS OF USE, DATA, OR PROFITS; OR BUSINESS INTERRUPTION) HOWEVER CAUSED AND ON ANY THEORY OF LIABILITY, WHETHER IN CONTRACT, STRICT LIABILITY, OR TORT (INCLUDING NEGLIGENCE OR OTHERWISE) ARISING IN ANY WAY OUT OF THE USE OF THIS SOFTWARE, EVEN IF ADVISED OF THE POSSIBILITY OF SUCH DAMAGE.

•libgloss

(1) Red Hat Incorporated
Copyright (c) 1994-2009 Red Hat, Inc. All rights reserved.

This copyrighted material is made available to anyone wishing to use, modify, copy, or redistribute it subject to the terms and conditions of the BSD License. This program is distributed in the hope that it will be useful, but WITHOUT ANY WARRANTY expressed or implied, including the implied warranties of MERCHANTABILITY or FITNESS FOR A PARTICULAR PURPOSE. A copy of this license is available at <http://www.opensource.org/licenses>. Any Red Hat trademarks that are incorporated in the source code or documentation are not subject to the BSD License and may only be used or replicated with the express permission of Red Hat, Inc..

(2) University of California, Berkeley
Copyright (c) 1981-2000 The Regents of the University of California. All rights reserved.

Redistribution and use in source and binary forms, with or without modification, are permitted provided that the following conditions are met:

- * Redistributions of source code must retain the above copyright notice, this list of conditions and the following disclaimer.
- * Redistributions in binary form must reproduce the above copyright notice, this list of conditions and the following disclaimer in the documentation and/or other materials provided with the distribution.
- * Neither the name of the University nor the names of its contributors may be used to endorse or promote products derived from this software without specific prior written permission.

THIS SOFTWARE IS PROVIDED BY THE COPYRIGHT HOLDERS AND CONTRIBUTORS "AS IS" AND ANY EXPRESS OR IMPLIED WARRANTIES, INCLUDING, BUT NOT LIMITED TO, THE IMPLIED WARRANTIES OF MERCHANTABILITY AND FITNESS FOR A PARTICULAR PURPOSE ARE DISCLAIMED. IN NO EVENT SHALL THE COPYRIGHT OWNER OR CONTRIBUTORS BE LIABLE FOR ANY DIRECT, INDIRECT, INCIDENTAL, SPECIAL, EXEMPLARY, OR CONSEQUENTIAL DAMAGES (INCLUDING, BUT NOT LIMITED TO, PROCUREMENT OF SUBSTITUTE GOODS OR SERVICES; LOSS OF USE, DATA, OR PROFITS; OR BUSINESS INTERRUPTION) HOWEVER CAUSED AND ON ANY THEORY OF LIABILITY, WHETHER IN CONTRACT, STRICT LIABILITY, OR TORT (INCLUDING NEGLIGENCE OR OTHERWISE) ARISING IN ANY WAY OUT OF THE USE OF THIS SOFTWARE, EVEN IF ADVISED OF THE POSSIBILITY OF SUCH DAMAGE.

(3) DJ Delorie
Copyright (C) 1993 DJ Delorie All rights reserved.

Redistribution, modification, and use in source and binary forms is permitted provided that the above copyright notice and following paragraph are duplicated in all such forms.

This file is distributed WITHOUT ANY WARRANTY; without even the implied warranty of MERCHANTABILITY or FITNESS FOR A PARTICULAR PURPOSE.

(4) (formerly GPL for fr30)
The GPL is no longer applicable to the fr30 platform. The piece of code (syscalls.c) referencing the GPL has been officially relicensed.

(5) Advanced Micro Devices
Copyright 1989, 1990 Advanced Micro Devices, Inc.

This software is the property of Advanced Micro Devices, Inc (AMD) which specifically grants the user the right to modify, use and distribute this software provided this notice is not removed or altered. All other rights are reserved by AMD.

AMD MAKES NO WARRANTY OF ANY KIND, EXPRESS OR IMPLIED, WITH REGARD TO THIS SOFTWARE. IN NO EVENT SHALL AMD BE LIABLE FOR INCIDENTAL OR CONSEQUENTIAL DAMAGES IN CONNECTION WITH OR ARISING FROM THE FURNISHING, PERFORMANCE, OR USE OF THIS SOFTWARE.

So that all may benefit from your experience, please report any problems or suggestions about this software to the 29K Technical Support Center at 800-29-29-AMD (800-292-9263) in the USA, or 0800-89-1131 in the UK, or 0031-11-1129 in Japan, toll free. The direct dial number is 512-462-4118.

Advanced Micro Devices, Inc.
29K Support Products
Mail Stop 573
5900 E. Ben White Blvd.
Austin, TX 78741
800-292-9263

(8) Sun Microsystems
Copyright (C) 1993 by Sun Microsystems, Inc. All rights reserved.

Developed at SunPro, a Sun Microsystems, Inc. business.
Permission to use, copy, modify, and distribute this software is freely granted, provided that this notice is preserved.

(9) Hewlett Packard
(c) Copyright 1986 HEWLETT-PACKARD COMPANY

To anyone who acknowledges that this file is provided "AS IS" without any express or implied warranty:

permission to use, copy, modify, and distribute this file for any purpose is hereby granted without fee, provided that the above copyright notice and this notice appears in all copies, and that the name of Hewlett-Packard Company not be used in advertising or publicity pertaining to distribution of the software without specific, written prior permission. Hewlett-Packard Company makes no representations about the suitability of this software for any purpose.

(10) Hans-Peter Nilsson
Copyright (C) 2001 Hans-Peter Nilsson

Permission to use, copy, modify, and distribute this software is freely granted, provided that the above copyright notice, this notice and the following disclaimer are preserved with no changes.

THIS SOFTWARE IS PROVIDED "AS IS" AND WITHOUT ANY EXPRESS OR IMPLIED WARRANTIES, INCLUDING, WITHOUT LIMITATION, THE IMPLIED WARRANTIES OF MERCHANTABILITY AND FITNESS FOR A PARTICULAR PURPOSE.

(14) - National Semiconductor Corporation
Copyright (c) 2004 National Semiconductor Corporation

The authors hereby grant permission to use, copy, modify, distribute, and license this software and its documentation for any purpose, provided that existing copyright notices are retained in all copies and that this notice is included verbatim in any distributions. No written agreement, license, or royalty fee is required for any of the authorized uses. Modifications to this software may be copyrighted by their authors and need not follow the licensing terms described here, provided that the new terms are clearly indicated on the first page of each file where they apply.

●libogg
Copyright (c) 2002, Xiph.org Foundation

Redistribution and use in source and binary forms, with or without modification, are permitted provided that the following conditions are met:

- Redistributions of source code must retain the above copyright notice, this list of conditions and the following disclaimer.

- Redistributions in binary form must reproduce the above copyright notice, this list of conditions and the following disclaimer in the documentation and/or other materials provided with the distribution.

- Neither the name of the Xiph.org Foundation nor the names of its contributors may be used to endorse or promote products derived from this software without specific prior written permission.

THIS SOFTWARE IS PROVIDED BY THE COPYRIGHT HOLDERS AND CONTRIBUTORS "AS IS" AND ANY EXPRESS OR IMPLIED WARRANTIES, INCLUDING, BUT NOT LIMITED TO, THE IMPLIED WARRANTIES OF MERCHANTABILITY AND FITNESS FOR A PARTICULAR PURPOSE ARE DISCLAIMED. IN NO EVENT SHALL THE FOUNDATION OR CONTRIBUTORS BE LIABLE FOR ANY DIRECT, INDIRECT, INCIDENTAL, SPECIAL, EXEMPLARY, OR CONSEQUENTIAL DAMAGES (INCLUDING, BUT NOT LIMITED TO, PROCUREMENT OF SUBSTITUTE GOODS OR SERVICES; LOSS OF USE, DATA, OR PROFITS; OR BUSINESS INTERRUPTION) HOWEVER CAUSED AND ON ANY THEORY OF LIABILITY, WHETHER IN CONTRACT, STRICT LIABILITY, OR TORT (INCLUDING NEGLIGENCE OR OTHERWISE) ARISING IN ANY WAY OUT OF THE USE OF THIS SOFTWARE, EVEN IF ADVISED OF THE POSSIBILITY OF SUCH DAMAGE.

●libopus
Copyright 2001-2011 Xiph.Org, Skype Limited, Octasic,
Jean-Marc Valin, Timothy B. Terriberry,
CSIRO, Gregory Maxwell, Mark Borgerding,
Erik de Castro Lopo

Redistribution and use in source and binary forms, with or without modification, are permitted provided that the following conditions are met:

- Redistributions of source code must retain the above copyright notice, this list of conditions and the following disclaimer.

- Redistributions in binary form must reproduce the above copyright notice, this list of conditions and the following disclaimer in the documentation and/or other materials provided with the distribution.

- Neither the name of Internet Society, IETF or IETF Trust, nor the names of specific contributors, may be used to endorse or promote products derived from this software without specific prior written permission.

THIS SOFTWARE IS PROVIDED BY THE COPYRIGHT HOLDERS AND CONTRIBUTORS "AS IS" AND ANY EXPRESS OR IMPLIED WARRANTIES, INCLUDING, BUT NOT LIMITED TO, THE IMPLIED WARRANTIES OF MERCHANTABILITY AND FITNESS FOR A PARTICULAR PURPOSE ARE DISCLAIMED. IN NO EVENT SHALL THE COPYRIGHT OWNER OR CONTRIBUTORS BE LIABLE FOR ANY DIRECT, INDIRECT, INCIDENTAL, SPECIAL, EXEMPLARY, OR CONSEQUENTIAL DAMAGES (INCLUDING, BUT NOT LIMITED TO, PROCUREMENT OF SUBSTITUTE GOODS OR SERVICES; LOSS OF USE, DATA, OR PROFITS; OR BUSINESS INTERRUPTION) HOWEVER CAUSED AND ON ANY THEORY OF LIABILITY, WHETHER IN CONTRACT, STRICT LIABILITY, OR TORT (INCLUDING NEGLIGENCE OR OTHERWISE) ARISING IN ANY WAY OUT OF THE USE OF THIS SOFTWARE, EVEN IF ADVISED OF THE POSSIBILITY OF SUCH DAMAGE.

Opus is subject to the royalty-free patent licenses which are specified at:

Xiph.Org Foundation:
<https://datatracker.ietf.org/ipr/1524/>

Microsoft Corporation:
<https://datatracker.ietf.org/ipr/1914/>

Broadcom Corporation:
<https://datatracker.ietf.org/ipr/1526/>

●littlefs
Copyright (c) 2017, Arm Limited. All rights reserved.

Redistribution and use in source and binary forms, with or without modification, are permitted provided that the following conditions are met:

- Redistributions of source code must retain the above copyright notice, this list of conditions and the following disclaimer.

- Redistributions in binary form must reproduce the above copyright notice, this list of conditions and the following disclaimer in the documentation and/or other materials provided with the distribution.

- Neither the name of ARM nor the names of its contributors may be used to endorse or promote products derived from this software without specific prior written permission.

THIS SOFTWARE IS PROVIDED BY THE COPYRIGHT HOLDERS AND CONTRIBUTORS "AS IS" AND ANY EXPRESS OR IMPLIED WARRANTIES, INCLUDING, BUT NOT LIMITED TO, THE IMPLIED WARRANTIES OF MERCHANTABILITY AND FITNESS FOR A PARTICULAR PURPOSE ARE DISCLAIMED. IN NO EVENT SHALL THE COPYRIGHT HOLDER OR CONTRIBUTORS BE LIABLE FOR ANY DIRECT, INDIRECT, INCIDENTAL, SPECIAL, EXEMPLARY, OR CONSEQUENTIAL DAMAGES (INCLUDING, BUT NOT LIMITED TO, PROCUREMENT OF SUBSTITUTE GOODS OR SERVICES; LOSS OF USE, DATA, OR PROFITS; OR BUSINESS INTERRUPTION) HOWEVER CAUSED AND ON ANY THEORY OF LIABILITY, WHETHER IN CONTRACT, STRICT LIABILITY, OR TORT (INCLUDING NEGLIGENCE OR OTHERWISE) ARISING IN ANY WAY OUT OF THE USE OF THIS SOFTWARE, EVEN IF ADVISED OF THE POSSIBILITY OF SUCH DAMAGE.

●opusfile
Copyright (c) 1994-2013 Xiph.Org Foundation and contributors

Redistribution and use in source and binary forms, with or without modification, are permitted provided that the following conditions are met:

- Redistributions of source code must retain the above copyright notice, this list of conditions and the following disclaimer.

- Redistributions in binary form must reproduce the above copyright notice, this list of conditions and the following disclaimer in the documentation and/or other materials provided with the distribution.

- Neither the name of the Xiph.Org Foundation nor the names of its contributors may be used to endorse or promote products derived from this software without specific prior written permission.

THIS SOFTWARE IS PROVIDED BY THE COPYRIGHT HOLDERS AND CONTRIBUTORS "AS IS" AND ANY EXPRESS OR IMPLIED WARRANTIES, INCLUDING, BUT NOT LIMITED TO, THE IMPLIED WARRANTIES OF MERCHANTABILITY AND FITNESS FOR A PARTICULAR PURPOSE ARE DISCLAIMED. IN NO EVENT SHALL THE FOUNDATION OR CONTRIBUTORS BE LIABLE FOR ANY DIRECT, INDIRECT, INCIDENTAL, SPECIAL, EXEMPLARY, OR CONSEQUENTIAL DAMAGES (INCLUDING, BUT NOT LIMITED TO, PROCUREMENT OF SUBSTITUTE GOODS OR SERVICES; LOSS OF USE, DATA, OR PROFITS; OR BUSINESS INTERRUPTION) HOWEVER CAUSED AND ON ANY THEORY OF LIABILITY, WHETHER IN CONTRACT, STRICT LIABILITY, OR TORT (INCLUDING NEGLIGENCE OR OTHERWISE) ARISING IN ANY WAY OUT OF THE USE OF THIS SOFTWARE, EVEN IF ADVISED OF THE POSSIBILITY OF SUCH DAMAGE.

●rnoise
Copyright (c) 2017, Mozilla
Copyright (c) 2007-2017, Jean-Marc Valin
Copyright (c) 2005-2017, Xiph.Org Foundation
Copyright (c) 2003-2004, Mark Borgerding

Redistribution and use in source and binary forms, with or without modification, are permitted provided that the following conditions are met:

- Redistributions of source code must retain the above copyright notice, this list of conditions and the following disclaimer.

- Redistributions in binary form must reproduce the above copyright notice, this list of conditions and the following disclaimer in the documentation and/or other materials provided with the distribution.

- Neither the name of the Xiph.Org Foundation nor the names of its contributors may be used to endorse or promote products derived from this software without specific prior written permission.

THIS SOFTWARE IS PROVIDED BY THE COPYRIGHT HOLDERS AND CONTRIBUTORS "AS IS" AND ANY EXPRESS OR IMPLIED WARRANTIES, INCLUDING, BUT NOT LIMITED TO, THE IMPLIED WARRANTIES OF MERCHANTABILITY AND FITNESS FOR A PARTICULAR PURPOSE ARE DISCLAIMED. IN NO EVENT SHALL THE FOUNDATION OR CONTRIBUTORS BE LIABLE FOR ANY DIRECT, INDIRECT, INCIDENTAL, SPECIAL, EXEMPLARY, OR CONSEQUENTIAL DAMAGES (INCLUDING, BUT NOT LIMITED TO, PROCUREMENT OF SUBSTITUTE GOODS OR SERVICES; LOSS OF USE, DATA, OR PROFITS; OR BUSINESS INTERRUPTION) HOWEVER CAUSED AND ON ANY THEORY OF LIABILITY, WHETHER IN CONTRACT, STRICT LIABILITY, OR TORT (INCLUDING NEGLIGENCE OR OTHERWISE) ARISING IN ANY WAY OUT OF THE USE OF THIS SOFTWARE, EVEN IF ADVISED OF THE POSSIBILITY OF SUCH DAMAGE.

MEMO

MEMO

售後服務

感謝您的愛護，本公司產品售後服務由台灣夏普客戶服務中心負責

消費者免費洽詢專線：0809-090-510

服務時間：星期一至星期日 09:00~21:00

SHARP

進口商：台灣夏普股份有限公司

進口商地址：新北市土城區中山路 16 號 7 樓

客戶服務專線：0809-090-510