

# SHARP



TINS-H747WJZZ

## 4T-C75FV1X



<https://global.sharp/restricted/support/aquos/emanual/asia/pdf/fv/android11/index.html>

請掃描上面的代碼以訪問 PDF 電子手冊。  
將應用互聯網收費的網絡。

Please scan the code above to access PDF E-Manual.  
The networks of the internet charges will be applied.

# AQUOS

## 液晶智能顯示器 初始設定指南

## LCD SMART MONITOR Initial setup guide

中國印製  
TINS-H747WJZZ  
23P06-CH-ZJ

### 親愛的 SHARP 顧客 / Dear SHARP customer

衷心感謝您購買 SHARP 液晶智能顯示器。為確保安全使用本機及多年使用本機，請務必在使用本產品前仔細閱讀重要的安全注意事項。

Thank you for your purchase of the SHARP Liquid Crystal Smart Monitor. To ensure safety and many years of trouble-free operation of your product, please read the Important Safety Precautions carefully before using this product.

#### 重要事項：

請將顯示器的型號和序號抄在右側空格內，萬一本機遺失或遭竊時將有助於資料的呈報。型號和製造號碼標示於顯示器的背面。

#### IMPORTANT:

To aid reporting in case of loss or theft, please record the Monitor's model and serial numbers in the space provided. The numbers are located at the rear of the Monitor.

型號/Model No. :

製造號碼/Serial No. :

本產品僅適用於台灣。 / This product is only for Taiwan.

### 重要資訊 / Important Information

**警告：**請勿將本產品曝露於雨水或置於潮濕環境中，以免引起火災或觸電。

**WARNING:** TO REDUCE THE RISK OF FIRE OR ELECTRIC SHOCK, DO NOT EXPOSE THIS PRODUCT TO RAIN OR MOISTURE.

	<b>注意 / CAUTION</b> 有觸電之虞 RISK OF ELECTRIC SHOCK 請勿拆開 DO NOT OPEN	
<p>小心：為防止觸電的危險，請勿拆除機殼（或後蓋）。內部並無使用者可自行維修之零件。請聯絡合格服務人員維修。</p> <p>CAUTION: TO REDUCE THE RISK OF ELECTRIC SHOCK, DO NOT REMOVE COVER (OR BACK). NO USER-SERVICEABLE PARTS INSIDE. REFER SERVICING TO QUALIFIED SERVICE PERSONNEL.</p>		

本符號是提醒您：在機器內部存有強度足以造成觸電危險的未絕緣「危險電壓」。

The lightning flash with arrow-head symbol, within an equilateral triangle, is intended to alert the user to the presence of uninsulated "dangerous voltage" within the product's enclosure that may be of sufficient magnitude to constitute a risk of electric shock to persons.

本符號是為了讓您注意本產品所附文件中的重要操作及保養（維修）指示。

The exclamation point within a triangle is intended to alert the user to the presence of important operating and maintenance (servicing) instructions in the literature accompanying the product.

小心：為防止觸電危險，插頭要完全插入電源插座。





**CAUTION:** TO PREVENT ELECTRIC SHOCK, MATCH WIDE BLADE OF PLUG TO WIDE SLOT, FULLY INSERT.

使用過度恐傷害視力。 / Overuse may damage eyesight.

使用30分鐘請休息10分鐘。 / Use 30 minutes, please rest for 10 minutes.

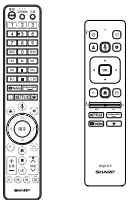
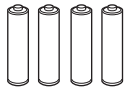
未滿2歲幼兒不看螢幕，2歲以上每天看螢幕不要超過1小時。 / Do not let children under age of 2 to watch the screen, children over age of 2 should not watch the screen for more than 1 hour per day.

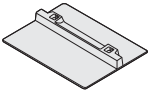
## A. 隨機附件 / Supplied accessories

<p>① 遙控器 (2 支) Remote control unit (× 2)</p> <p>Type A      Type B</p> 	<p>② “AAA” 型鹼性電池 (4 顆) “AAA” size battery (× 4)</p> 	<p>③ 初始設定指南 Initial setup guide 保證書 Warranty Certificate</p>
<p>④ 底座支架 (2 個) Stand bar (× 2)</p> 	<p>⑤ 臺座基座 (1 個) Base of stand (× 1)</p> 	
<p>⑥ 螺絲釘 (10 顆) Screws (× 10)</p> 	<p>⑦ 交流電源線 (1 根) AC cord (× 1)</p> 	

## B. 裝入電池 Inserting the batteries

### 遙控器 Remote control unit (Type A)

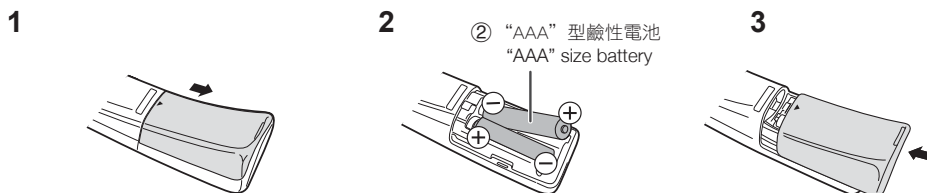

### 遙控器 Remote control unit (Type B)

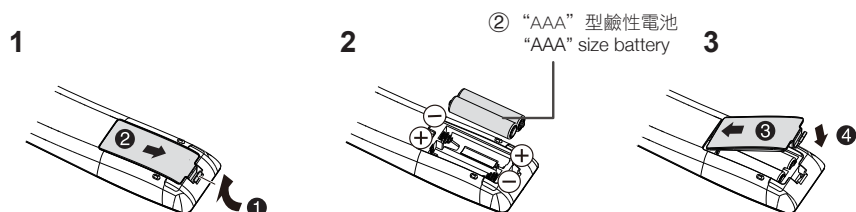

- 在裝入電池時，要注意電池端子的極性要與電池艙內的極性標記 (+) 和 (-) 一致。
- Place batteries with their terminals corresponding to the (+) and (-) indications in the battery compartment.



廢電池請回收

Recycle the battery

## C. 連接台座單位 / Attaching the stand

組裝前請檢查以下注意事項。 Please check the following precautions before assembling.

- 不要把顯示器螢幕向下。  
Do not lay the Monitor screen down.
- 不要取下螢幕保護墊 (紙板) 保護螢幕直到安裝完成。  
To protect the screen, do not remove the screen protector pad (cardboard) until installation is complete.
- 始終與兩個或更多人一起工作。請勿握住顯示器的四個角。  
Always work with two or more people. Do not hold the four corners of the Monitor.



### 1 將底座支架插入臺座基座。

To insert stand bar to the base of stand.

- 將底座支架上的“△”標記與臺座基座背面對齊，插入臺座基座直至聽到咔嗒聲。  
Align the “△” mark on the stand bar with the back of the base of stand and insert it into the base of stand until it clicks.

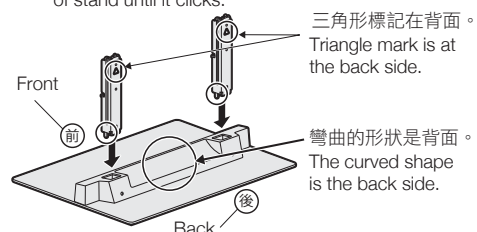

### 2 用六顆用於組裝台座的螺絲固定底座支架與臺座基座。

Fix the stand bar and the base of stand with six screws for assembling the stand.

- 將上側的底座支架放在地板上，和臺座基座的後側朝下，然後擰緊螺絲。  
Place the upper side of the stand bar on the floor and the rear side of the base of stand facing down, and then tighten the screws.
- 如下圖所示將支架倒置並用六顆螺絲固定。  
Turn the stand upside down as shown in the figure below and secure it with the six screws.

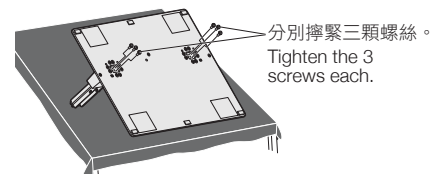

### 請注意 Caution

- 為防止劃傷地板等，擰螺絲時，請在上面鋪上毯子之類的東西。  
In order to prevent scratches on the floor, etc., when screwing, please put blanket or etc. on it.

### 3 拿出顯示器

Take out the Monitor.

- 撕掉顯示器螢幕一側的膠帶，然後請把袋子滑下來。  
Peel off the tape on the Monitor screen side and slide the bag down.

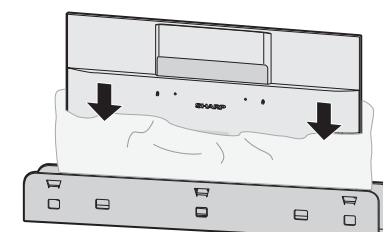

- 顯示器裝完成前請勿取下螢幕保護墊。  
Do not remove the screen protection pad until the Monitor installation is complete.

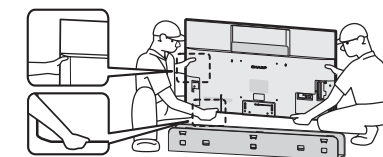

確保與兩個或更多人一起工作。  
Ensure to work with two or more people.

## C. 連接台座單位 (續) / Attaching the stand (Continued)

### 4 將顯示單元安裝到支架上，同時保持單元處於直立位置。

Attach the display unit to the stand while keeping the unit in upright position.

- 將顯示單元上的“▽”標記與底座支架對齊，並在插入底座支架的同時慢慢放下。

Align the “▽” mark on the display unit with the stand bar and slowly lower it while inserting into the stand bar.

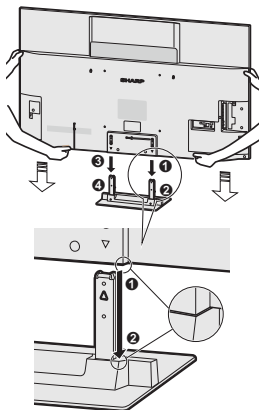

- 設置轉角位置，使 1 和 2、3 和 4 對齊，然後慢慢垂直放下。

Set the corner position so that 1 and 2, 3 and 4 are aligned, and slowly lower it vertically.

#### 請注意 Caution

- 小心不要讓您的手指夾在顯示部分和台座之間。

Be careful not to get your fingers caught between the display part and the stand.

### 5 請使用附件的四根螺絲釘，固定顯示部分和臺座基座。

Fix the Monitor and base of stand with four screws provided.

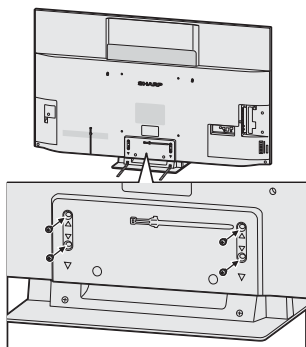

#### 請注意 Caution

- 安裝顯示器和底座支架時，請擰緊固定。
- 固定完成後，請輕搖確認所有的螺絲釘是否擰緊。
- 安裝完成后，如果發現顯示器有傾斜狀況，請稍稍擰鬆螺絲釘，使顯示器回向水平方向移動後，再次擰緊螺絲釘。
- When installing the Monitor and the stand bar, please tighten it.
- After fixing, please shake to confirm whether all the screws are tightened.
- After the installation is complete, if you find that the Monitor is tilted, please loosen the screws slightly to make the Monitor shift to the horizontal, and then tighten the screws again.

#### 如何取下支架 How to remove the stand

請按照“連接台座單位”中相反的步驟卸下支架。Remove the stand by following the steps in "Attaching the stand" in reverse order.

- 按照以下步驟從臺座基座卸下底座支架。

Follow the steps below to remove the stand bar from the base of stand.

#### 1- 卸下螺絲。

Remove the screws.

#### 請注意 Caution

- 為防止劃傷地板等，拆卸螺絲時，請在上面鋪上毯子之類的東西。
- 請勿卸下或鬆開其他螺絲。
- In order to prevent scratches on the floor, etc., when removing the screws, please put blanket or etc. on it.
- Do not remove or loosen other screws.

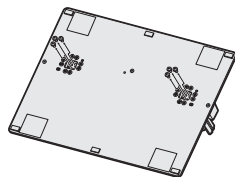

#### 2- 從臺座基座卸下底座支架。

Remove the stand bar from the base of stand.

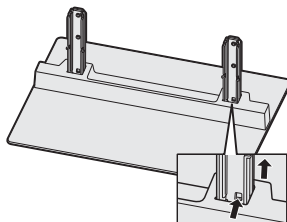

- 使用棒狀物體將突出部分推過底座支架中的孔，然後向上拉底座支架。

Use a stick-shaped object to push the protrusion through the hole in the stand bar and pull the stand bar upward.

## 重要的安全注意事項

[中文 ㊦]

- 必須安裝台座，以防止顯示器跌落造成傷害。
- 清理—清理產品前，請從交流電源插座上拔下交流電源線。使用柔軟濕潤的布料來清理產品。請勿使用液態清潔劑，氣溶膠清潔劑或沾染化學藥品的布料來清理，因為此類材料可能會損壞產品。
- 水和潮濕—不要在近水之處使用本機，例如在靠近洗澡盆，洗臉盆，廚房洗滌槽，洗衣盆，游泳池等，也不要潮濕的地下室中使用。
- 請勿在本機之上放置花瓶或任何其他盛水的容器。若有水滴濺到本機上，就可能引起火災或觸電。
- 不要將本機放置於不穩定的推車，台座，三腳架或桌面上。不穩固的基座可能會使本機掉落，導致嚴重的人身傷害以及造成產品損壞。請僅使用本製造商所推薦或與本產品配套出售的推車，台座，三腳架，托架或桌子。將本機安裝與牆上時，請務必遵照本製造商的指示。而且只可以使用本製造商所推薦的安裝器材。
- 將本機放置於推車上搬運時，必須小心注意安全。急停，用力過度，地面不平等，都會導致本機從推車上掉落。
- 通風—本機外殼上的散熱孔與其他開口處都是用於散熱通風。請勿堵塞這些散熱孔或開口處，通風散熱不良會使本機過熱和/或縮短本機的使用壽命。請勿將本機置於臥室，沙發，地毯或其他類似物品上，因為這些物品會堵塞散熱通風孔。本機之設計不適用於嵌入式安裝；所以不要將本機置於像書櫃，機架等封閉之處，除非提供合適的通風或遵照本製造商的指示安裝。
- 本機所用之液晶顯示器用玻璃製造的。因此，在受到強力撞擊或遭到尖銳物品刻劃時會破損。萬一液晶顯示器破碎，請小心不要被破碎玻璃割傷。
- 熱源—請勿讓本機接近熱源，如暖氣機，加熱器，爐灶或者其他任何會產生熱能的產品（包括廣大機在內）。
- 為防止發生火災，請勿將任何種類的蠟燭或火焰置于顯示器上或其附近。
- 為了防止火災或觸電的危險，請勿將交流電源線置于顯示器或其他重物下。
- 請勿在本機之上放置重物或攀附於本機之上。這樣做可能導致本機傾倒而造成傷害。特別要注意附近的兒童和寵物。
- 液晶螢幕採用極高精度技術製造，有效像素達到 99.99% 以上。0.01% 或以下的缺失像素，或者那些始終亮著的像素不是故障。

#### 在搬運顯示器時的注意事項

在搬運顯示器時，切勿握持或施加壓力於顯示器上。任何時候都必須由兩個人或多人用雙手搬運—顯示器的每一側用一雙手握住。

- 請勿長時間顯示靜止畫面，這可能會導致殘留影像。
- 請將本機安裝於能夠很容易地將交流電源線從交流電源插座和本機機背後的 AC INPUT（交流電源輸入）端子上撥出的地方。
- 如果顯示器不是放置在平穩的地方，顯示器可能有掉落的危險。很多尤其對於兒童的傷害，可以通過採取簡單的預防措施而避免，例如：
  - 使用本顯示器製造商所推薦的櫥櫃或台座。
  - 僅使用可以安全支撐顯示器的家具。
  - 確保顯示器沒有外伸在支撐家具的邊緣。
  - 在沒有錨固家具和顯示器於適合的支座的情況下，勿將顯示器放置在高的家具上（例如櫥櫃或書架）。
  - 請勿將顯示器放置在布料或其他放置在顯示器和支撐家具之間的物質上。
  - 教導兒童有關攀爬家具以觸及顯示器或控制器的危險。
- 請勿將顯示器安裝在空調機下方或加濕器附近等會受到水滴影響的位置。
  - 水滴掉落在顯示器上並進入其中可能會造成起火，電擊或故障。
  - 建議您將顯示器安裝在距離冷氣出風口至少 1m 的位置。

※根據NCC低功率射頻器材技術規範3.8.2規定：

- 取得審驗證明之低功率射頻器材，非經核准，公司、商號或使用者均不得擅自變更頻率、加大功率或變更原設計之特性及功能。
- 低功率射頻器材之使用不得影響飛航安全及干擾合法通信；經發現有干擾現象時，應立即停用，並改善至無干擾時方得繼續使用。前述合法通信，指依電信管理法規定作業之無線電通信。
- 低功率射頻器材須忍受合法通信或工業、科學及醫療用電波輻射性電機設備之干擾。

#### 設備上的符號



- 此標誌表示產品在交流電壓下工作。



- 此標誌表示 II 類或雙重絕緣電器，其中產品不需要電氣接地的安全連接。

## 初始安裝

第一次使用本顯示器時，請按照以下步驟逐一操作。視您的顯示器安裝與連接而定，可能不需要進行某些步驟。

- 1 將交流電源線插入主機的交流電源插座。  
將交流電源線插入交流電源插座。
- 將顯示器放在靠近交流電源插座的位置，以便電源插頭就近使用。

### 注意

為避免電擊危險，切勿接觸連接了交流電的未絕緣零件或任何電線。

- 2 按下顯示器上的 (飛梭鍵)。

- 3 執行初始安裝。
  - 按照顯示器螢幕上的指示設置設定。

使用 AV IN 的說明。  
需要 RCA 插孔轉換。  
購買維修部件 (QCNWGA252WJPZ)。

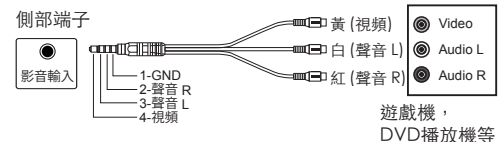

## 端子圖

顯示器 (背面)

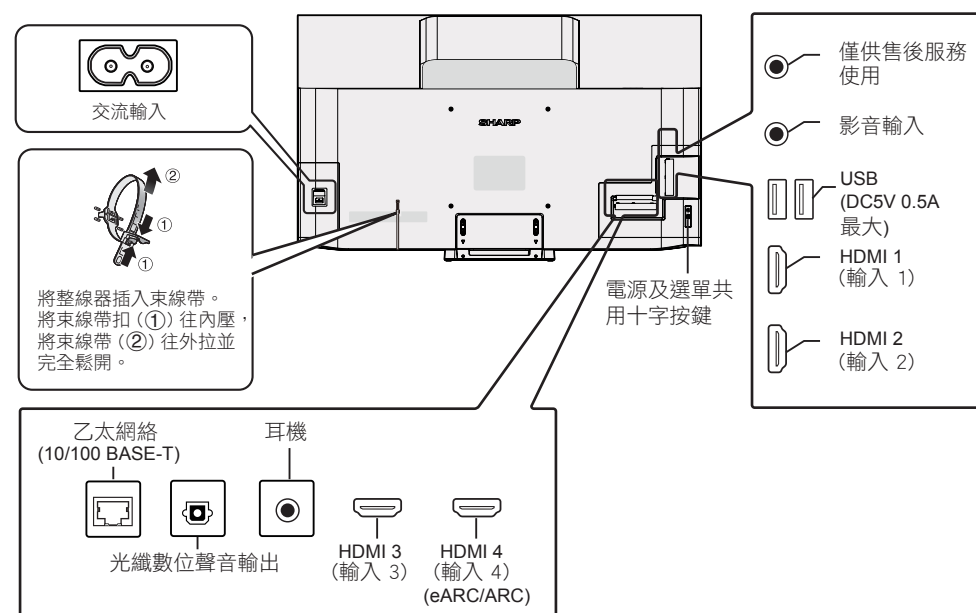

## 觀看電子手冊

### 觀看內建操作手冊

內建操作指南顯示於螢幕上。您可以閱讀此裝置的操作說明。  
需要連接互聯網。

- 1 按下 (首頁)，顯示 HOME (首頁) 畫面，按下 選擇「手冊」。  
然後按下 **確定/OK**。將顯示內建操作手冊畫面。
- 2 選擇目錄時，將顯示其頁面。



## 附錄

### 疑難排解

下述問題並非一定由於故障而引起。將顯示器送修之前，請再次檢查顯示器。

問題	可能的解決方案
• 沒有電源。	<ul style="list-style-type: none"><li>• 檢查是否按下了遙控器上的 "電源" 按鍵。</li><li>• AC電源線是否中斷連接？</li><li>• 主電源是否被打開？</li></ul>
• 遙控器無法運作。	<ul style="list-style-type: none"><li>• 電池是否按極性 (+、-) 放入？</li></ul>
• 沒有影像。	<ul style="list-style-type: none"><li>• 與其他組件的連接是否正確？</li></ul>
• 沒有聲音。	<ul style="list-style-type: none"><li>• 與其他組件的連接是否正確？</li></ul>

### 清除密碼

如果您忘記了密碼，請依照下列步驟來清除密碼。

- 1 在資訊主頁畫面中，選擇「設定」>「系統」>「關於」>「重設」>「恢復原廠設定」，然後按下 **確定/OK**。
- 2 顯示器重置後將恢復原廠設定，需重設密碼。

### 註

- 預設 PIN 碼為「1234」。
- 以防萬一，請記下密碼並妥善保管。

### 免責聲明

- 本 SHARP 裝置促進存取第三方提供的內容和服務。透過本裝置存取的內容和服務屬於第三方，而且可能專屬於第三方。因此，此類第三方內容和服務的任何使用都必須依照該內容或服務供應商提供的任何授權或使用條款。若您未能遵從該授權或使用條款，SHARP 對於您或任何第三方概不負責。除非適用內容或服務供應商特別授權，否則提供的所有第三方內容和服務僅供個人和非商業用途；您不得透過任何方式或媒體修改、複製、分發、傳送、展示、執行、重製、上傳、發佈、授權、創建衍生創作、轉讓或出售透過此裝置提供的任何內容或服務。
- 對於第三方內容或服務相關的顧客服務相關議題，SHARP 概不負責。對於與第三方內容或服務相關的任何問題、意見或服務相關的疑問，應直接諮詢適用的內容或服務提供商。  
您可能會由於與裝置本身無關的各種原因而無法從裝置存取內容或服務，包括但不限於停電、其他網際網路連接，或未能正確配置裝置。對於此類故障或維修產生的中斷，不論原因為何或本來是否能夠避免 SHARP、其董事、管理人員、僱員、代理人、承包商和子公司對於您或任何第三方概不負責。
- 所有可透過本裝置存取的第三方內容或服務係基於「可用性」以「現狀」提供給您，SHARP 與其子公司沒有對您作出任何擔保或聲明，不論是明示或暗示，包括但不限於對於提供給您的內容或服務之適銷性、不侵權、適合特定用途、適用性、可用性、準確性、完整性、安全性、所有權、實用性、無過失或無錯誤或不中斷操作或使用的任何擔保，也不擔保內容或服務將符合您的需求或期望。
- SHARP 並非第三方內容或服務供應商的代理人，而且對於第三方內容或服務供應商的行為或疏忽以及與該第三方供應商相關的任何內容或服務方面概不負責。
- 在任何情況下，對於您或任何第三方的任何直接、間接、特殊、偶然、懲罰性、後果性或其他損失，不論責任理論是基於合約、侵權、過失、違反保證、嚴格責任或其他方面，而且無論 SHARP 和/或其子公司是否已被告知發生此類損害的可能性，SHARP 和/或其子公司概不負責。



## 規格

項目	型號	4T-C75FV1X
液晶面板 (斜對角線距離)		189 cm
解析度		8,294,400 像素 (3840 × 2160)
視頻彩色系統		PAL / SECAM / NTSC 3.58 / NTSC 4.43 / PAL 60
音頻放大器		共 85W [(15W × 2)+(10W × 2)+(10W × 2)+ 15W]
端子	HDMI 1 (輸入 1)	HDMI 4K, ALLM
	HDMI 2 (輸入 2)	HDMI 4K, ALLM
	HDMI 3 (輸入 3)	HDMI 4K, ALLM/VRR (120P)
	HDMI 4 (輸入 4)	HDMI 4K, ALLM/VRR (120P), eARC/ARC
	影音輸入	φ 3.5 mm 插孔 (音頻輸入, 視訊輸入)
	USB	USB 2.0 (DC5V 0.5A 最大)
	USB	USB 2.0 (DC5V 0.5A 最大)
	乙太網絡 (10/100 BASE-T)	網路連接器
	光纖數位聲音輸出	光學 S/PDIF 數位聲音輸出
	耳機	φ 3.5 mm 立體聲
僅供售後服務使用		φ 2.5 mm 插孔
WiFi通訊協定		IEEE 802.11 a/b/g/n/ac 2T/2R 雙頻
WiFi通訊安全		WPA3-個人, WPA2-個人, WPA-個人
Bluetooth		V2.1 + EDR / 4.2 / 5.1
螢幕顯示語言		英文/簡體中文/繁體中文(台灣)/繁體中文(香港)/阿拉伯語/法語/泰語/葡萄牙語/越南語/印地語/俄語/馬來語/印尼語
額定電壓額定頻率		AC 110 V, 60 Hz
額定消耗電功率 (待機)		510W (0.5 W)
尺寸	不含台座 寬 × 高 × 深 (mm)	1667 × 970 × 88
	含台座 寬 × 高 × 深 (mm)	1667 × 1014 × 335
不含台座重量 (含台座重量)		40.5 kg (46.5 kg)
操作溫度		0°C 到 + 40°C

- 作為不斷改進政策的一部份, SHARP 保留改進產品而變更設計和規格的權利, 恕不另行通知。以上性能規格的數值為產品設備的標稱值。個別設備的相關數值可能略有差異。

### 注意

- 安裝液晶顯示器要專業技術, 因此必須由合格的維修人員進行。顧客不應自行嘗試安裝。SHARP 對由於安裝不當或安裝造成的事故或傷害不承擔任何責任。
- 開始操作前, 請詳細閱讀托架隨附的說明。
- 請勿在傾斜狀態下安裝/壁掛顯示器。

## Important Safety Precautions

[ENGLISH 

- Stand base must be attached to prevent the Monitor set from falling down and cause injuries.
- Cleaning — Unplug the AC cord from the AC outlet before cleaning the product. Use a soft damp cloth to clean the product. Do not use liquid cleaners, aerosol cleaners or chemical cloth to clean it, as such materials may damage the product.
- Water and moisture — Do not use the product near water, such as bathtub, washbasin, kitchen sink, laundry tub, swimming pool and in a wet basement.
- Do not place vases or any other water-filled containers on this product. The water may spill onto the product causing fire or electric shock.
- Stand — Do not place the product on an unstable cart, stand, tripod or table. Doing so can cause the product to fall, resulting in serious personal injuries as well as damage to the product. Use only a cart, stand, tripod, bracket or table recommended by the manufacturer or sold with the product. When mounting the product on a wall, be sure to follow the manufacturer's instructions. Use only the mounting hardware recommended by the manufacturer.
- When relocating the product placed on a cart, it must be moved with utmost care. Sudden stops, excessive force and uneven floor surface can cause the product to fall from the cart.
- Ventilation — The vents and other openings in the cabinet are designed for ventilation. Do not cover or block these vents and openings since insufficient ventilation can cause overheating and/or shorten the life of the product. Do not place the product on a bed, sofa, rug or other similar surface, since they can block ventilation openings. This product is not designed for built-in installation; do not place the product in an enclosed place such as a bookcase or rack, unless proper ventilation is provided or the manufacturer's instructions are followed.
- The LCD panel used in this product is made of glass. Therefore, it can break when the product is struck forcefully or with a sharp object. If the LCD panel is broken, be careful not to be injured by broken glass.
- Heat sources — Keep the product away from heat sources such as radiators, heaters, stoves and other heat-generating products (including amplifiers).
- To prevent fire, never place any type of candle or naked flames on the top or near the Monitor set.
- To prevent fire or shock hazard, do not place the AC power cord under the Monitor set or other heavy items.
- Do not place heavy objects on this product or stand on it. Doing so could cause injury if the product overturns. Take special care near children and pets.
- The LCD panel is made with extremely high precision technology, and has 99.99% or more effective pixels. The 0.01% or less missing pixels or those that are always lit is not a malfunction.

### Precautions when transporting the Monitor

When transporting the Monitor, never carry it by holding or otherwise putting pressure onto the display. Be sure to always carry the Monitor by two people holding it with two hands — one hand on each side of the Monitor.

- Do not display a still picture for a long time, as this could cause an afterimage to remain.
- Install the product on the place where the AC cord can be unplugged easily from the AC outlet or from the AC INPUT terminal on the rear of the product.
- If a Monitor is not positioned in a sufficiently stable location, it can be potentially hazardous due to falling. Many injuries, particularly to children, can be avoided by taking simple precautions such as:
  - Using cabinets or stands recommended by the manufacturer of the Monitor.
  - Only using furniture that can safely support the Monitor.
  - Ensuring the Monitor is not overhanging the edge of the supporting furniture.
  - Not placing the Monitor on tall furniture (for example, cupboards or bookcases) without anchoring both the furniture and the Monitor to a suitable support.
  - Not standing the Monitor on cloth or other materials placed between the Monitor and supporting furniture.
  - Educating children about the dangers of climbing on furniture to reach the Monitor or its controls.
- Do not install the Monitor in a location in which it will be subject to water drops such as underneath an air conditioning unit or in the vicinity of a humidifier.
  - Water drops falling onto the Monitor and water entering inside it may result in fire, electric shock, or malfunctions.
  - We recommend that you install the Monitor at least 1m away from the outlet of an air conditioner.

### Symbols placed on equipment



- This mark indicates the product operates on AC Voltage.



- This mark indicates a class II or double insulated electrical appliance wherein the product does not require a safety connection to electrical earth (ground).

## Initial installation

Follow the steps below one by one when using the Monitor for the first time. Some steps may not be necessary depending on your Monitor installation and connection.

- 1 Plug the AC cord into the AC inlet of the main unit.  
Plug the AC cord into the AC outlet.
- 2 Place the Monitor close to the AC outlet, and keep the power plug within reach.

- 3 Run the initial installation.
  - Follow the guide on the Monitor screen to set the settings.

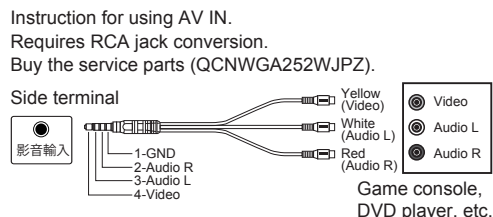

## Terminal Diagram

Monitor (Rear)

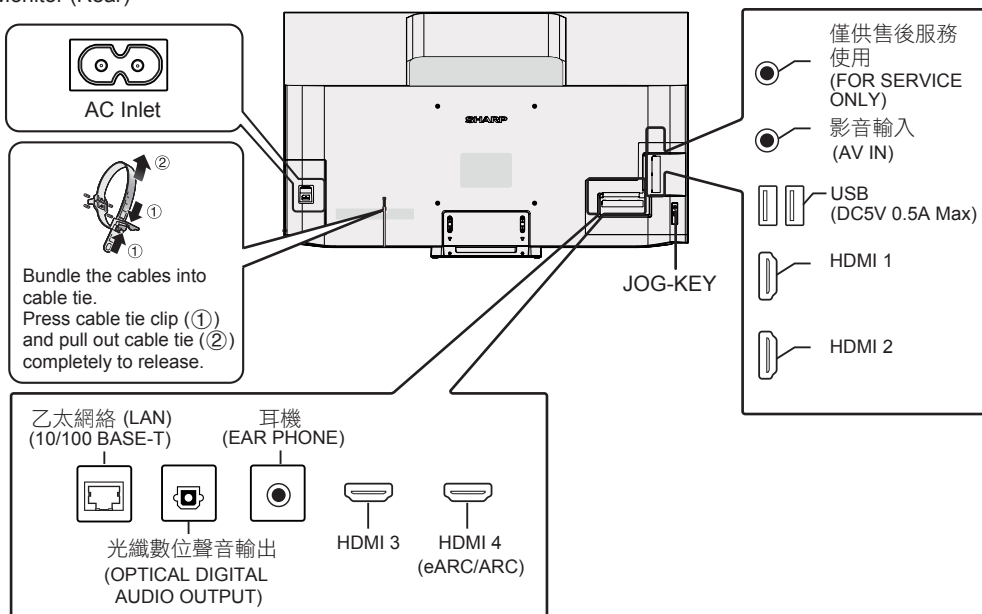

## Viewing E-Manual

### Viewing the Built-in Operation Manual

Displays the built-in operation manual on the screen. You can read information about how to use this device.

The internet connection will be required.

- 1 Press **HOME** to display the HOME screen, press **</>** to select "Manual", and then press **確定 (ENTER)/OK**.
- 2 When you select contents, its page will be displayed.



## Appendix

### Troubleshooting

The problems described below are not always caused by malfunctions. Check the Monitor again before having the Monitor serviced.

Problem	Possible Solution
<ul style="list-style-type: none"> <li>• No power.</li> </ul>	<ul style="list-style-type: none"> <li>• Check if you pressed 電源 (POWER) on the remote control unit.</li> <li>• Is the AC cord disconnected?</li> <li>• Has the power been turned on?</li> </ul>
<ul style="list-style-type: none"> <li>• Remote control unit does not operate.</li> </ul>	<ul style="list-style-type: none"> <li>• Are batteries inserted with polarity ( + , - ) aligned?</li> </ul>
<ul style="list-style-type: none"> <li>• No picture.</li> </ul>	<ul style="list-style-type: none"> <li>• Is connection to other components correct?</li> </ul>
<ul style="list-style-type: none"> <li>• No sound.</li> </ul>	<ul style="list-style-type: none"> <li>• Is connection to other components correct?</li> </ul>

### Clearing the password

If you forget the password, clear the password using the following procedure.

- 1 From the Dashboard, select "Settings" > "System" > "About" > "Reset" > "Factory reset", and then press **確定 (ENTER)/OK**.
- 2 When you perform a reset, the Monitor will be returned to the factory preset values, and you need to set the password again.

#### NOTE

- The default PIN is "1234".
- As a precautionary measure, make a note of your password, and keep it in a safe place.

### DISCLAIMERS

- This SHARP device facilitates the access to content and services provided by third parties. The content and services accessible via this device belong to and may be proprietary to third parties. Therefore, any use of such third party content and services must be in accordance with any authorization or terms of use provided by such content or service provider. SHARP shall not be liable to you or any third party for your failure to abide by such authorization or terms of use. Unless otherwise specifically authorized by the applicable content or service provider, all third party content and services provided are for personal and non-commercial use; you may not modify, copy, distribute, transmit, display, perform, reproduce, upload, publish, license, create derivative works from, transfer or sell in any manner or medium any content or services available via this device.
- SHARP is not responsible, nor liable, for customer service-related issues related to the third party content or services. Any questions, comments or service-related inquiries relating to the third party content or service should be made directly to the applicable content or service provider. You may not be able to access content or services from the device for a variety of reasons which may be unrelated to the device itself, including, but not limited to, power failure, other Internet connection, or failure to configure your device properly. SHARP, its directors, officers, employees, agents, contractors and affiliates shall not be liable to you or any third party with respect to such failures or maintenance outages, regardless of cause or whether or not it could have been avoided.
- ALL THIRD PARTY CONTENT OR SERVICES ACCESSIBLE VIA THIS DEVICE IS PROVIDED TO YOU ON AN "AS-IS" AND "AS AVAILABLE" BASIS AND SHARP AND ITS AFFILIATES MAKE NO WARRANTY OR REPRESENTATION OF ANY KIND TO YOU, EITHER EXPRESS OR IMPLIED, INCLUDING, WITHOUT LIMITATION, ANY WARRANTIES OF MERCHANTABILITY, NON-INFRINGEMENT, FITNESS FOR A PARTICULAR PURPOSE OR ANY WARRANTIES OF SUITABILITY, AVAILABILITY, ACCURACY, COMPLETENESS, SECURITY, TITLE, USEFULNESS, LACK OF NEGLIGENCE OR ERROR-FREE OR UNINTERRUPTED OPERATION OR USE OF THE CONTENT OR SERVICES PROVIDED TO YOU OR THAT THE CONTENT OR SERVICES WILL MEET YOUR REQUIREMENTS OR EXPECTATIONS.
- SHARP IS NOT AN AGENT OF AND ASSUMES NO RESPONSIBILITY FOR THE ACTS OR OMISSIONS OF THIRD PARTY CONTENT OR SERVICE PROVIDERS, NOR ANY ASPECT OF THE CONTENT OR SERVICE RELATED TO SUCH THIRD PARTY PROVIDERS.
- IN NO EVENT WILL SHARP AND/OR ITS AFFILIATES BE LIABLE TO YOU OR ANY THIRD PARTY FOR ANY DIRECT, INDIRECT, SPECIAL, INCIDENTAL, PUNITIVE, CONSEQUENTIAL OR OTHER DAMAGES, WHETHER THE THEORY OF LIABILITY IS BASED ON CONTRACT, TORT, NEGLIGENCE, BREACH OF WARRANTY, STRICT LIABILITY OR OTHERWISE AND WHETHER OR NOT SHARP AND/OR ITS AFFILIATES HAVE BEEN ADVISED OF THE POSSIBILITY OF SUCH DAMAGES.

## Specifications

Item	Model	4T-C75FV1X
LCD panel		189 cm
Resolution		8,294,400 pixels (3840 × 2160)
Video colour system		PAL/SECAM/NTSC 3.58/NTSC 4.43/PAL 60
Audio amplifier		Total 85W [(15W × 2) + (10W × 2) + (10W × 2) + 15W ]
Terminals	HDMI 1	HDMI 4K, ALLM
	HDMI 2	HDMI 4K, ALLM
	HDMI 3	HDMI 4K, ALLM/VRR (120P)
	HDMI 4	HDMI 4K, ALLM/VRR (120P), eARC/ARC
	影音輸入 (AV IN)	φ 3.5 mm jack (AUDIO in, VIDEO in)
	USB	USB 2.0 (DC5V 0.5A Max)
	USB	USB 2.0 (DC5V 0.5A Max)
	乙太網絡 LAN (10/100 BASE-T)	Network connector
	光纖數位聲音輸出 (OPTICAL DIGITAL AUDIO OUT)	Optical S/PDIF digital audio output
	耳機 (EAR PHONE)	φ 3.5 mm stereo
僅供售後服務使用 (FOR SERVICE ONLY)	φ 2.5 mm jack	
WIFI Protocol		IEEE 802.11 a/b/g/n/ac 2T/2R Dual Band
WIFI Security		WPA3-Personal, WPA2-Personal, WPA-Personal
Bluetooth		V2.1 + EDR / 4.2 / 5.1
OSD language		English/Simplified Chinese/Traditional Chinese(TW)/ Traditional Chinese(HK)/ Arabic/French/Thai/Portuguese/Vietnamese/ Hindi/Russian/Bahasa Malaysia/ Bahasa Indonesia
Power requirement		AC 110V, 60Hz
Power consumption (Standby)		510 W (0.5 W)
Dimensions	without stand W x H x D (mm)	1667 × 970 × 88
	with stand W x H x D (mm)	1667 × 1014 × 335
Weight without stand (with stand)		40.5 kg (46.5 kg)
Operating temperature		0°C to + 40°C

- As a part of policy of continuous improvement, SHARP reserves the right to make design and specification changes for product improvement without prior notice. The performance specification figures indicated are nominal values of production units. There may be some deviations from these values in individual units.

### CAUTION

- Installing the Liquid Crystal Monitor requires special skill that should only be performed by qualified service personnel. Customers should not attempt to do the work themselves. SHARP bears no responsibility for improper mounting or mounting that results in accident or injury.
- Carefully read the instructions that come with the bracket before beginning work.
- Do not install / mount the Monitor with tilting condition.

## Appendix

### Trademarks

Google TV is the name of this device's software experience and a trademark of Google LLC. Google, YouTube, Google Photos, Chromecast built-in and other marks are trademarks of Google LLC.

Google Assistant is not available in certain languages and countries. Availability of services varies by country and language.

Dolby, Dolby Vision IQ, Dolby Vision, Dolby Atmos, Dolby Audio, and the double-D symbol are trademarks of Dolby Laboratories Licensing Corporation. Manufactured under license from Dolby Laboratories. Confidential unpublished works. Copyright © 1992–2022 Dolby Laboratories. All rights reserved.

The terms HDMI, HDMI High-Definition Multimedia Interface, HDMI trade dress and the HDMI Logos are trademarks or registered trademarks of HDMI Licensing Administrator, Inc.

The Wi-Fi CERTIFIED™ Logo is a certification mark of Wi-Fi Alliance®.

The Bluetooth® word mark and logos are registered trademarks owned by Bluetooth SIG, Inc. and any use of such marks by SHARP Corporation is under license. Other trademarks and trade names are those of their respective owners.

Covered by one or more claims of the HEVC patents listed at [patentlist.accessadvance.com](http://patentlist.accessadvance.com).

ANY USE OF THIS PRODUCT IN ANY MANNER OTHER THAN PERSONAL USE THAT COMPLIES WITH THE MPEG-2 STANDARD FOR ENCODING VIDEO INFORMATION FOR PACKAGED MEDIA IS EXPRESSLY PROHIBITED WITHOUT A LICENSE UNDER APPLICABLE PATENTS IN THE MPEG-2 PATENT PORTFOLIO, WHICH LICENSE IS AVAILABLE FROM MPEG LA, LLC, 6312 S. Fiddlers Green Circle, Suite 400 E, Greenwood Village, Colorado 80111 U.S.A.

THIS PRODUCT IS LICENSED UNDER THE VC-1 PATENT PORTFOLIO LICENSE FOR THE PERSONAL AND NON-COMMERCIAL USE OF A CONSUMER TO (i) ENCODE VIDEO IN COMPLIANCE WITH THE VC-1 STANDARD ("VC-1 VIDEO") AND/OR (ii) DECODE VC-1 VIDEO THAT WAS ENCODED BY A CONSUMER ENGAGED IN A PERSONAL AND NON-COMMERCIAL ACTIVITY AND/OR WAS OBTAINED FROM A VIDEO PROVIDER LICENSED TO PROVIDE VC-1 VIDEO. NO LICENSE IS GRANTED OR SHALL BE IMPLIED FOR ANY OTHER USE. ADDITIONAL INFORMATION MAY BE OBTAINED FROM MPEG LA, L.L.C. SEE [HTTP://WWW.MPEGLA.COM](http://WWW.MPEGLA.COM)

THIS PRODUCT IS LICENSED UNDER THE AVC PATENT PORTFOLIO LICENSE FOR THE PERSONAL USE OF A CONSUMER OR OTHER USES IN WHICH IT DOES NOT RECEIVE REMUNERATION TO (i) ENCODE VIDEO IN COMPLIANCE WITH THE AVC STANDARD ("AVC VIDEO") AND/OR (ii) DECODE AVC VIDEO THAT WAS ENCODED BY A CONSUMER ENGAGED IN A PERSONAL ACTIVITY AND/OR WAS OBTAINED FROM A VIDEO PROVIDER LICENSED TO PROVIDE AVC VIDEO. NO LICENSE IS GRANTED OR SHALL BE IMPLIED FOR ANY OTHER USE. ADDITIONAL INFORMATION MAY BE OBTAINED FROM MPEG LA, L.L.C. SEE [HTTP://WWW.MPEGLA.COM](http://WWW.MPEGLA.COM)

THIS PRODUCT IS LICENSED UNDER THE MPEG-4 VISUAL PATENT PORTFOLIO LICENSE FOR THE PERSONAL AND NON-COMMERCIAL USE OF A CONSUMER FOR (i) ENCODING VIDEO IN COMPLIANCE WITH THE MPEG-4 VISUAL STANDARD ("MPEG-4 VIDEO") AND/OR (ii) DECODING MPEG-4 VIDEO THAT WAS ENCODED BY A CONSUMER ENGAGED IN A PERSONAL AND NON-COMMERCIAL ACTIVITY AND/OR WAS OBTAINED FROM A VIDEO PROVIDER LICENSED BY MPEG LA TO PROVIDE MPEG-4 VIDEO. NO LICENSE IS GRANTED OR SHALL BE IMPLIED FOR ANY OTHER USE. ADDITIONAL INFORMATION INCLUDING THAT RELATING TO PROMOTIONAL, INTERNAL AND COMMERCIAL USES AND LICENSING MAY BE OBTAINED FROM MPEG LA, L.L.C. SEE [HTTP://WWW.MPEGLA.COM](http://WWW.MPEGLA.COM)

## 輪廓圖/Dimensional Drawing

單位: 公釐 / Unit : mm

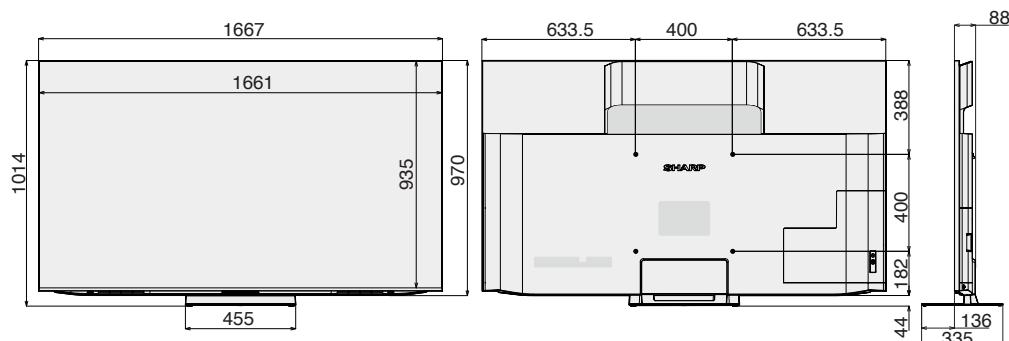

壁掛孔距規格 / VESA SPEC	400 x 400
上/下側壁掛螺釘孔深度 / UPPER/LOWER VESA SCREW DEPTH	30
上/下側壁掛螺釘規格 / UPPER/LOWER VESA SCREW TYPE	M6

## 限用物質及其化學符號 / Restricted substances and its chemical symbols

設備名稱：液晶智能顯示器， 型號（型式）：4T-C75FV1X  
Equipment name : LCD Smart Monitor , Type designation (Type) : 4T-C75FV1X

單元 Unit	限用物質及其化學符號 Restricted substances and its chemical symbols					
	鉛 Lead (Pb)	汞 Mercury (Hg)	鎘 Cadmium (Cd)	六價鉻 Hexavalent chromium (Cr <sup>6+</sup> )	多溴聯苯 Polybrominated biphenyls (PBB)	多溴二苯醚 Polybrominated diphenyl ethers (PBDE)
電路板 Printed Circuit Board	○	○	○	○	○	○
後殼 Rear Cabinet	○	○	○	○	○	○
面板 Panel	-	○	○	○	○	○
電源線 Electric current wires	○	○	○	○	○	○
其他線材 Other Wiring Material	-	○	○	○	○	○
配件 (例：遙控器等) Accessories (Example: Remote control etc.)	-	○	○	○	○	○

備考1. “超出0.1 wt %”及“超出0.01 wt %”係指限用物質之百分比含量超出百分比含量基準值。  
Note 1: “Exceeding 0.1 wt %” and “exceeding 0.01 wt %” indicate that the percentage content of the restricted substance exceeds the reference percentage value of presence condition.

備考2. “○”係指該項限用物質之百分比含量未超出百分比含量基準值。  
Note 2: “○” indicates that the percentage content of the restricted substance does not exceed the percentage of reference value of presence.

備考3. “-”係指該項限用物質為排除項目。  
Note 3: The “-” indicates that the restricted substance corresponds to the exemption.

## 售後服務

感謝您的愛護，本公司產品售後服務由台灣夏普客戶服務中心負責

消費者免費洽詢專線：0809-090-510

服務時間：星期一至星期日 09:00~21:00

## After-sales service

Thank you for your care. The 台灣夏普 Customer Service Center is responsible for the after-sales service of our products.

Special line for free customer inquiry:  
**0809-090-510**

Working hours: 09:00 - 21:00 from Monday to Sunday

## SHARP

進口商 / Importer: 台灣夏普股份有限公司

進口商地址 / Address of importer: 新北市土城區中山路16號7樓

客戶服務專線 / Special line for customer service: 0809-090-510

# SHARP

SHARP CORPORATION